



# KNX VOC/TH-UP Touch

## Combined indoor sensor

---

Item numbers 70970 (pure white), 70973 (black)

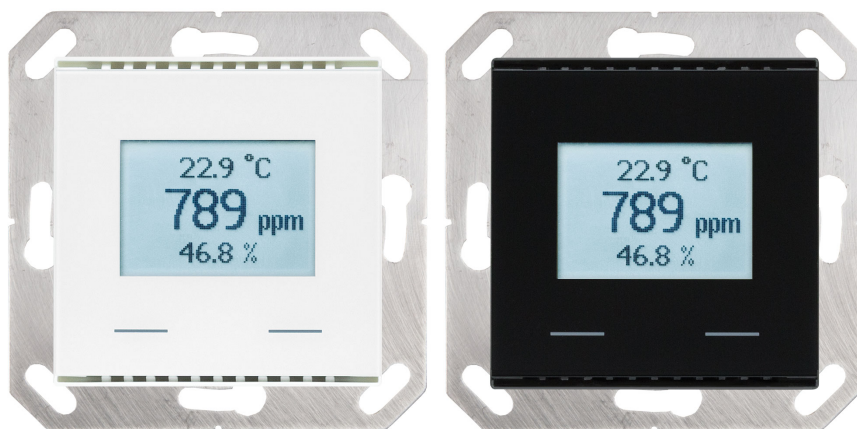



<b>1. Description .....</b>	<b>5</b>
1.1. Scope of delivery .....	6
1.2. Technical specifications .....	6
1.2.1. Accuracy of the measurement .....	7
1.2.2. Measuring ranges of different gases (CO <sub>2</sub> equivalents) .....	7
<b>2. Installation and commissioning .....</b>	<b>8</b>
2.1. Installation notes .....	8
2.2. Installation position .....	8
2.3. Composition .....	10
2.3.1. Housing .....	10
2.4. Assembly of the sensor .....	10
2.5. Notes on mounting and commissioning .....	10
<b>3. Addressing of the device at the bus .....</b>	<b>11</b>
<b>4. Display and operation at the device .....</b>	<b>11</b>
4.1. Mode display and manual temperature controller .....	11
4.2. Change ambient temperature with the buttons .....	13
<b>5. Transfer protocol .....</b>	<b>14</b>
5.1. List of all communications objects .....	14
<b>6. Parameter setting .....</b>	<b>23</b>
6.1. Behaviour on power failure/ restoration of power .....	23
6.2. General settings .....	23
6.3. Temperature value .....	23
6.4. Temperature threshold values .....	24
6.4.1. Threshold value 1, 2, 3 .....	24
6.4.1.1. Threshold value .....	24
6.4.1.2. Switching output .....	25
6.4.1.3. Block .....	26
6.5. Temperature PI control .....	26
6.5.0.1. General control .....	27
6.5.1. General set point values .....	29
6.5.1.1. Set point Comfort .....	30
6.5.1.2. Standby setpoint .....	30
6.5.1.3. Eco setpoint .....	31
6.5.1.4. Setpoint values for frost/heat protection (building protection) .....	31
6.5.1.5. General control variables .....	32
6.5.2. Heating control level 1/2 .....	32
6.5.3. Cooling control level 1/2 .....	34
6.6. Humidity measurement .....	36
6.7. Humidity threshold values .....	37
6.7.1. Threshold value 1, 2 .....	37
6.7.1.1. Threshold value .....	37
6.7.1.2. Switching output .....	38

6.7.1.3. Block .....	39
6.8. Humidity PI control .....	40
6.8.0.1. General control .....	40
6.8.0.2. Controller setpoint .....	40
6.8.0.3. Dehumidification and/or humidification .....	42
6.9. Dewpoint measurement .....	42
6.9.1. Cooling medium temp. monitoring .....	43
6.9.1.1. Threshold value .....	43
6.9.1.2. Switching output .....	44
6.9.1.3. Blocking .....	44
6.10. Absolute humidity .....	45
6.11. Comfort field .....	45
6.12. VOC parameter settings .....	46
6.13. VOC threshold values .....	46
6.13.1. Threshold value 1, 2, 3, 4 .....	47
6.13.1.1. Threshold value .....	47
6.13.1.2. Switching output .....	48
6.13.1.3. Block .....	48
6.14. VOC PI-control .....	49
6.14.0.1. General control .....	49
6.14.0.2. Controller setpoint .....	50
6.14.0.3. Ventilation control .....	51
6.15. Variable comparator .....	51
6.15.1. Control variable comparator 1/2 .....	51
6.16. Logic .....	52
6.16.0.1. AND logic .....	52
6.16.0.2. OR logic .....	52
6.16.1. AND logic 1-4 and OR logic outputs 1-4 .....	53
6.16.1.1. Block .....	54
6.16.2. Connection inputs of the AND logic .....	54
6.16.3. Connection inputs of the OR logic .....	56
6.17. Display .....	56
6.18. Pushbutton .....	59
6.18.1. Pushbutton for temperature control .....	60
6.18.2. Pushbutton interface .....	60



Installation, inspection, commissioning and troubleshooting of the device must only be carried out by a competent electrician.

This manual is amended periodically and will be brought into line with new software releases. The change status (software version and date) can be found in the contents footer. If you have a device with a later software version, please check **www.elsner-elektronik.de** in the menu area "Service" to find out whether a more up-to-date version of the manual is available.

## Clarification of signs used in this manual



Safety advice.



Safety advice for working on electrical connections, components, etc.

### **DANGER!**

... indicates an immediately hazardous situation which will lead to death or severe injuries if it is not avoided.

### **WARNING!**

... indicates a potentially hazardous situation which may lead to death or severe injuries if it is not avoided.

### **CAUTION!**

... indicates a potentially hazardous situation which may lead to trivial or minor injuries if it is not avoided.



**ATTENTION!** ... indicates a situation which may lead to damage to property if it is not avoided.

### ETS

In the ETS tables, the parameter default settings are marked by underlining.



# 1. Description

---

The **Sensor KNX VOC/TH-UP Touch** measures volatile organic compounds in the room air, temperature and humidity and calculates the dew point. The sensor can receive external measured values via the bus and process them with the own data to overall values (mixed values, e. g. room average). The **KNX VOC/TH-UP Touch** offers two push buttons that may be used for changing the ambient temperature (target value), for switching between operating modes or as free programmable bus push buttons.

The **KNX VOC/TH-UP Touch** provides switching outputs with adjustable threshold values. The switching outputs and further communication objects can be linked by AND and OR logic gates. Additionally, an integrated actuating variable comparator can compare and output values that are received via communication objects.

Integrated PI controllers allows for control of a ventilation (depending on VOC concentration and air humidity) and a heating/cooling system (depending on temperature). The **KNX VOC/TH-UP Touch** can emit a warning to the bus as soon as the area of optimum comfort (according to DIN 1946) is left.

The integrated display shows the own values and data received from the bus (e.g. date, time). The device is completed with a frame of the switching series installed in the building and thus merges with the interior.

## Functions:

- Measurement of **VOC** (volatile organic compounds) in the air. In this process, an air quality value in CO<sub>2</sub> equivalents is calculated via an algorithm from the sum signal of all compounds included in the mixed gas.
- Measurement of **temperature** and **air humidity** (absolute and relative), calculation of the dew point
- **Mixed values** from own measured values and external values (proportions can be set in percentage)
- **Display** 1-3 rows (own values or values received from the bus) or display of temperature control (see *Mode display and manual temperature controller*)
- **2 push buttons**. Configuration as bus push button or for changing ambient temperature and switching between operating modes (see *Change ambient temperature with the buttons*)
- **PI controller for heating** (one or two step) and **cooling** (one or two step) depending on temperature. Control according to separate target values or basic target temperature
- **PI controller for ventilation** depending on humidity and VOC concentration: dehumidification/humidification (one step) or dehumidification (one or two step)
- **Threshold values** can be adjusted per parameter or via communication objects: 3 × temperature, 2 × humidity, 4 × VOC
- **4 AND and 4 OR logic gates** with each 4 inputs. Every switching incident as well as 16 logic inputs in the form of communication objects, may be used as inputs for the logic gates. The output of each gate may optionally be configured as 1 bit or 2 × 8 bits

- **2 actuating variable comparators** for output of minimum, maximum or average values. Each with 5 inputs (for values received via communication objects)

Configuration is made using the KNX software ETS 5. The **product file** can be downloaded from the ETS online catalogue and the Elsner Elektronik website on [www.elsner-elektronik.de](http://www.elsner-elektronik.de) in the "Service" menu.

## 1.1. Scope of delivery

- Housing with display
- Base plate

You will need *in addition* (not supplied):

- Socket Ø 60 mm, 42 mm deep
- Frame (for element 55 x 55 mm), suitable for the switching programme used in the building

## 1.2. Technical specifications

Housing	Plastic material
Colours	<ul style="list-style-type: none"> <li>• similar to RAL 9005 jet black</li> <li>• similar to RAL 9010 pure white</li> </ul>
Mounting	In-wall (wall mounting in socket Ø 60 mm, 42 mm deep, resp. cavity wall socket for hole Ø 68 mm)
Protection category	IP 20
Dimensions	Housing approx. 55 x 55 (W x H, mm), mounting depth approx. 8 mm, base plate approx. 71 x 71 (W x H, mm)
Total weight	approx. 68 g
Ambient temperature	Operation 0...+50°C, storage -10...+60°C
Ambient air humidity	min. 10% RH, max. 95% RH, avoid bedewing
Operating voltage	KNX bus voltage
Bus current	max. 20 mA
Data output	KNX +/- bus terminal plug
BCU type	Own micro controller
PEI type	0
Group addresses	max. 254
Allocations	max. 254
Communication objects	224
VOC measurement range	400...2000 ppm
VOC resolution	1 ppm
Temperature measurement range	0...+50°C
Temperature resolution	0.1°C
Temperature accuracy	± 0.5°C at 0...+50°C (Mind the notes on <i>Accuracy of the measurement</i> )



Humidity measurement range	0% RH ...95% RH
Humidity resolution	0.1%
Humidity accuracy	±7.5% RH at 0...10% RH ±4.5% RH at 10...90% RH ±7.5% RH at 90...95% RH
Humidity drift	± 0.5% RH per year in normal air

The product conforms with the provisions of EU guidelines.

### 1.2.1. Accuracy of the measurement

Measurement variations from permanent sources of interference (see chapter *Installation position*) can be corrected in the ETS in order to ensure the specified accuracy of the sensor (offset).

To ensure a correct **VOC measurement**, the device must be installed in a windproof socket.

When **measuring temperature**, the self-heating of the device is considered by the electronics. The heating is compensated by the software.

### 1.2.2. Measuring ranges of different gases (CO<sub>2</sub> equivalents)

Corresponding VOC concentrations for specific representatives

Compound	Formula	Range* (ppm)	Potential sources of pollutants indoors
Carbon monoxide	CO	0-10	Car exhaust, fuel-based heating, cooking appliances, smoking
Methane	CH <sub>4</sub>	0-200	Natural gas
Propane	C <sub>3</sub> H <sub>8</sub>	0-20	Fuel-based heating, cooking appliances, cleaners
Ethyl alcohol	C <sub>2</sub> H <sub>6</sub> O	0-3	Cosmetics, cleaners, disinfectants, detergents, paints, coatings, breath
Acetaldehyde	C <sub>2</sub> H <sub>4</sub> O	0-20	Adhesives, coatings, plastics, lubricants, ripening of fruits
Methylethylketone	C <sub>4</sub> H <sub>8</sub> O	0-20	Adhesives, coatings, plastics, lubricants
Toluene	C <sub>7</sub> H <sub>8</sub>	0-5	Paints, coatings, cleaners, detergents, smoking, polyurethane lacquers

\* corresponding concentration range based on lab measurements at gas mixing system with synthetic air at 50% r.h. and RT

---

## 2. Installation and commissioning

---

### 2.1. Installation notes

---



Installation, testing, operational start-up and troubleshooting should only be performed by an electrician.

---



#### **CAUTION!** **Live voltage!**

There are unprotected live components inside the device.

- National legal regulations are to be followed.
  - Ensure that all lines to be assembled are free of voltage and take precautions against accidental switching on.
  - Do not use the device if it is damaged.
  - Take the device or system out of service and secure it against unintentional use, if it can be assumed, that risk-free operation is no longer guaranteed.
- 

The device is only to be used for its intended purpose. Any improper modification or failure to follow the operating instructions voids any and all warranty and guarantee claims.

After unpacking the device, check it immediately for possible mechanical damage. If it has been damaged in transport, inform the supplier immediately.

The device may only be used as a fixed-site installation; that means only when assembled and after conclusion of all installation and operational start-up tasks and only in the surroundings designated for it.

Elsner Elektronik is not liable for any changes in norms and standards which may occur after publication of these operating instructions.

### 2.2. Installation position

---

The **Sensor KNX VOC/TH-UP Touch** is made for wall mounting in a socket (Ø 60 mm, 42 mm deep).

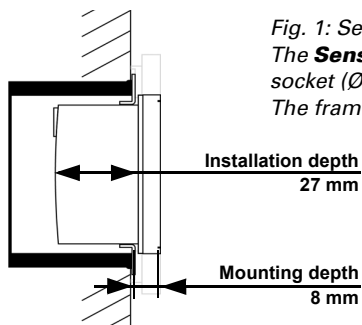

Fig. 1: Sectional drawing.

The **Sensor KNX VOC/TH-UP Touch** fits into a standard socket (Ø 60 mm, depth 42 mm).

The frame is not included!



**May be installed and operated in dry interior rooms only.  
Avoid condensation.**

When selecting an installation location, please ensure that the measurement results are affected as little as possible by external influences. Possible sources of interference include:

- Direct sunlight
- Drafts from windows and doors
- Draft from ducts which lead from other rooms or from the outside to the junction box in which the sensor is mounted
- Warming or cooling of the building structure on which the sensor is mounted, e.g. due to sunlight, heating or cold water pipes
- Connection lines and ducts which lead from warmer or colder areas to the sensor

Measurement variations from permanent sources of interference can be corrected in the ETS in order to ensure the specified accuracy of the sensor (offset).

To ensure a correct VOC measurement, the device must be installed in a windproof socket.

## 2.3. Composition

### 2.3.1. Housing

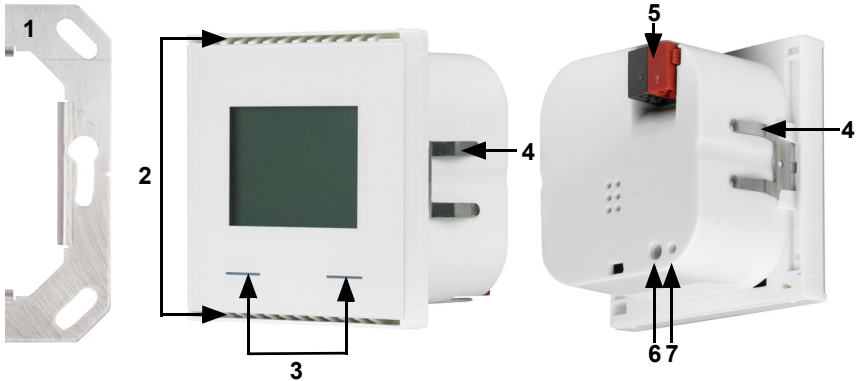

Fig. 2

- 1 Base plate
- 2 Openings for air circulation
- 3 Touch sensitive buttons
- 4 Catches
- 5 KNX terminal BUS +/-
- 6 Programming button (recessed) for teaching device
- 7 Programming LED (recessed)

## 2.4. Assembly of the sensor

First of all fit the windproof socket with connection. Also seal inlet pipes to avoid infiltration.

Screw the base plate onto the socket and position the frame of the switching programme. Connect the bus line +/- to the black-red plug.

Pin the housing with the notches on to the metal frame, so that device and frame are fixed.

## 2.5. Notes on mounting and commissioning

Never expose the device to water (e.g. rain) or dust. This can damage the electronics. You must not exceed a relative humidity of 95%. Avoid condensation.

After the bus voltage has been applied, the device will enter an initialisation phase lasting a few seconds. During this phase no information can be received or sent via the bus.

### 3. Addressing of the device at the bus

The device is supplied with the bus address 15.15.255. You can program another address into the ETS by overwriting the 15.15.255 address or by teaching via the programming button.

## 4. Display and operation at the device

Detailed specifications for the display and the use of the push buttons are set in the ETS.

Basically the display can show a two-row or three-row text (e. g. for measured values) or a temperature controller. You can switch between the two types by pressing one of the buttons, if this has not been disabled in the ETS.

### 4.1. Mode display and manual temperature controller

Depending on the ETS setting selected, the mode display will only display show the current target value, or the base target value setting with scale display. The manually adjustable range can be set in the ETS.

The following display options are available:

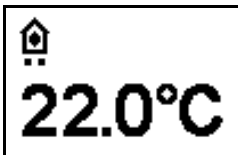

*Fig. 3*

Mode display with current target value and/or base target value

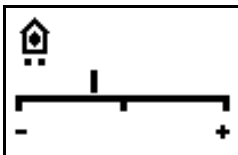

*Fig. 4*

Mode display with scale display for adjusting the base target value. The control position in the image reads "Base target value reduced".

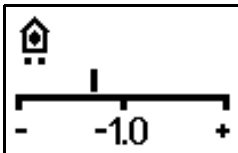

*Fig. 5*

Mode display with scale display and number. Shows the set target value change. The control position in the image reads "Base target value reduced to 1.0°".

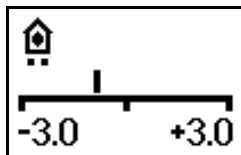

Fig. 6

Mode display with scale display and range. Shows the possible adjustment range (as set in the ETS). The control position in the image reads "Base target value reduced".

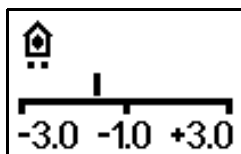







Fig. 7

Mode display with scale display, range and number. Displays the possible adjustment range (as set in the ETS) and the set target value change. The control position in the image reads "Base target value reduced to 1.0°".

### Symbols

	Comfort mode. Comfort (present) target temperature will be used.		Standby mode. Standby (absent during day) target temperature will be used.
	Eco mode. Night target temperature will be used.		Building protection mode. Building protection target temperature will be used. The symbol will blink when the mode has been activated but the activation delay has not yet expired.
	Heating mode. Heating will be provided.		Cooling mode Cooling will be provided.

### Priority (points)

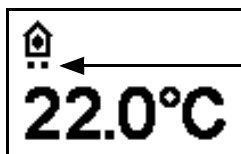

Fig. 8

In "HVAC mode with 2x 8 bits" control mode, points are shown under the symbol, to indicate the running priority of the current mode.

One point: Priority 1/priority control. It is not possible to adjust the temperature automation system manually. Neither the target temperature nor the operating modes can be changed using the buttons on the unit.

Two points: Priority 2. The target temperature and operating mode can be changed using the buttons.

## 4.2. Change ambient temperature with the buttons

If the mode display is active, the target ambient temperature and the operating mode can be changed manually using the buttons. The button functions can be blocked in the ETS or be suppressed for Priority 1 operating modes. The individual operating modes can also be locked for manual selection in the ETS.

Decrease target temperature (-)	briefly press left button	Ambient temperature in the current mode is decreased. The sep-size is defined in the ETS (0.1°C to 5°C).
Increase target temperature (+)	briefly press right button	Ambient temperature in the current mode is increased. The sep-size is defined in the ETS (0.1°C to 5°C).
Change mode	press left or right button longer than 2 secs.	Changes between the operating modes Comfort, Standby, Eco and Building Protection (if deblocked in the ETS).
Extend Comfort mode	in Eco mode: press both buttons at the same time longer than 2 secs.	Switches from Eco to Comfort mode again for a certain time (e. g. if the rooms are used longer in the evening). The period is defined in the ETS (up to 10 hours). The time remaining in Comfort mode is displayed.

## 5. Transfer protocol

### Units:

Temperatures in degrees Celsius

Air humidity in %

Absolute air humidity in g/kg and/or g/m<sup>3</sup>

VOC content in ppm

Variables in %

### 5.1. List of all communications objects

#### Abbreviation flags:

C Communication

R Read

W Write

T Transfer

U Update

No	Text	Function	Flags	DPT type	Size
0	Software version	readable	R-CT	[217.1] DPT_Version	2 Bytes
1	Malfunction temperature/humidity sensor	Output	R-CT	[1.1] DPT_Switch	1 Bit
2	VOC sensor malfunction	Output	R-CT	[1.1] DPT_Switch	1 Bit
3	External measured value for temperature	Input	-WC-	[9.1] DPT_Value_Temp	2 Bytes
4	Internal measured value for temperature	Output	R-CT	[9.1] DPT_Value_Temp	2 Bytes
5	Total measured value for temperature	Output	R-CT	[9.1] DPT_Value_Temp	2 Bytes
6	Request min./max. temperature measured value	Input	-WC-	[1.17] DPT_Trigger	1 Bit
7	Minimum measured value for temperature	Output	R-CT	[9.1] DPT_Value_Temp	2 Bytes
8	Maximum measured value for temperature	Output	R-CT	[9.1] DPT_Value_Temp	2 Bytes
9	Reset min./max. measured value for temperature	Input	-WC-	[1.17] DPT_Trigger	1 Bit
10	Temp. thresholdV 1: Absolute value	Input / Output	RWC T	[9.1] DPT_Value_Temp	2 Bytes
11	Temp. thresholdV 1: (1:+   0:-)	Input	-WC-	[1.2] DPT_Bool	1 Bit
12	Temp. thresholdV 1: Switching delay from 0 to 1	Input	-WC-	[7.5] DPT_TimePeriodSec	2 Bytes
13	Temp. thresholdV 1: Switching delay from 1 to 0	Input	-WC-	[7.5] DPT_TimePeriodSec	2 Bytes



No	Text	Function	Flags	DPT type	Size
14	Temp. thresholdV 1: Switching output	Output	R-CT	[1.1] DPT_Switch	1 Bit
15	Temp. thresholdV 1: Switching output block	Input	-WC-	[1.2] DPT_Bool	1 Bit
16	Temp. thresholdV 2: Absolute value	Input / Output	RWC T	[9.1] DPT_Value_Temp	2 Bytes
17	Temp. thresholdV 2: (1:+   0:-)	Input	-WC-	[1.2] DPT_Bool	1 Bit
18	Temp. thresholdV 2: Switching delay from 0 to 1	Input	-WC-	[7.5] DPT_TimePeriodSec	2 Bytes
19	Temp. thresholdV 2: Switching delay from 1 to 0	Input	-WC-	[7.5] DPT_TimePeriodSec	2 Bytes
20	Temp. thresholdV 2: Switching output	Output	R-CT	[1.1] DPT_Switch	1 Bit
21	Temp. thresholdV 2: Switching output block	Input	-WC-	[1.2] DPT_Bool	1 Bit
22	Temp. thresholdV 3: Absolute value	Input / Output	RWC T	[9.1] DPT_Value_Temp	2 Bytes
23	Temp. thresholdV 3: (1:+   0:-)	Input	-WC-	[1.2] DPT_Bool	1 Bit
24	Temp. thresholdV 3: Switching delay from 0 to 1	Input	-WC-	[7.5] DPT_TimePeriodSec	2 Bytes
25	Temp. thresholdV 3: Switching delay from 1 to 0	Input	-WC-	[7.5] DPT_TimePeriodSec	2 Bytes
26	Temp. thresholdV 3: Switching output	Output	R-CT	[1.1] DPT_Switch	1 Bit
27	Temp. thresholdV 3: Switching output block	Input	-WC-	[1.2] DPT_Bool	1 Bit
29	Temp.control: HVAC mode (priority 1)	Input / Output	RWC T	[20.102] DPT_HVAC-Mode	1 Byte
30	Temp.control: HVAC mode (priority 2)	Input / Output	RWC T	[20.102] DPT_HVAC-Mode	1 Byte
31	Temp.control: Mode frost/heat protection activ.	Input / Output	RWC T	[1.1] DPT_Switch	1 Bit
32	Temp.control: Block (On when value = 1)	Input	-WC-	[1.1] DPT_Switch	1 Bit
33	Temp.control: Current setpoint	Output	R-CT	[9.1] DPT_Value_Temp	2 Bytes
34	Temp.control: Switch. (Heating = 0   Cooling = 1)	Input	-WC-	[1.1] DPT_Switch	1 Bit
35	Temp.control: Setpoint Comfort heating	Input / Output	RWC T	[9.1] DPT_Value_Temp	2 Bytes
36	Temp.control: Setpoint Comfort heat.(1:+   0:-)	Input	-WC-	[1.1] DPT_Switch	1 Bit
37	Temp.control: Setpoint Comfort cooling	Input / Output	RWC T	[9.1] DPT_Value_Temp	2 Bytes

No	Text	Function	Flags	DPT type	Size
38	Temp.control: Setpoint Comfort cool.(1:+   0:-)	Input	-WC-	[1.1] DPT_Switch	1 Bit
39	Temp.control: Basic 16-bit setpoint shift	Input / Output	RWC T	[9.1] DPT_- Value_Temp	2 Bytes
40	Temp.control: Setpoint Standby heating	Input / Output	RWC T	[9.1] DPT_- Value_Temp	2 Bytes
41	Temp.control: Setpoint Standby heat.(1:+   0:-)	Input	-WC-	[1.1] DPT_Switch	1 Bit
42	Temp.control: Setpoint Standby cooling	Input / Output	RWC T	[9.1] DPT_- Value_Temp	2 Bytes
43	Temp.control: Setpoint Standby cool. (1:+   0:-)	Input	-WC-	[1.1] DPT_Switch	1 Bit
44	Temp.control: Setpoint Eco heating	Input / Output	RWC T	[9.1] DPT_- Value_Temp	2 Bytes
45	Temp.control: Setpoint Eco heating (1:+   0:-)	Input	-WC-	[1.1] DPT_Switch	1 Bit
46	Temp.control: Setpoint Eco cooling	Input / Output	RWC T	[9.1] DPT_- Value_Temp	2 Bytes
47	Temp.control: Setpoint Eco cooling (1:+   0:-)	Input	-WC-	[1.1] DPT_Switch	1 Bit
48	Temp.control: Control variable heating (level 1)	Output	R-CT	[5.1] DPT_Scaling	1 Byte
49	Temp.control: Control variable heating (level 2)	Output	R-CT	[5.1] DPT_Scaling	1 Byte
50	Temp.control: Control variable cooling (level 1)	Output	R-CT	[5.1] DPT_Scaling	1 Byte
51	Temp.control: Control variable cooling (level 2)	Output	R-CT	[5.1] DPT_Scaling	1 Byte
52	Temp.control: Status Heat. level 1 (1=ON 0=OFF)	Output	R-CT	[1.1] DPT_Switch	1 Bit
53	Temp.control: Status Heat. level 2 (1=ON 0=OFF)	Output	R-CT	[1.1] DPT_Switch	1 Bit
54	Temp.control: Status Cool. level 1 (1=ON 0=OFF)	Output	R-CT	[1.1] DPT_Switch	1 Bit
55	Temp.control: Status Cool. level 2 (1=ON 0=OFF)	Output	R-CT	[1.1] DPT_Switch	1 Bit
56	Temp.control: Comfort extension status	Input / Output	RWC T	[1.1] DPT_Switch	1 Bit
57	Temp.control: Comfort Extension time	Input	RWC T	[7.5] DPT_TimePeriodSec	2 Bytes
58	Temperature control: Variable for 4/6-way valve	Output	R-CT	[5.1] DPT_Scaling	1 Byte
59	External measured value for humidity	Input	-WC-	[9.7] DPT_Value_Humidity	2 Bytes

No	Text	Function	Flags	DPT type	Size
60	Internal measured value for humidity	Output	R-CT	[9.7] DPT_Value_Humidity	2 Bytes
61	Total measured value for humidity	Output	R-CT	[9.7] DPT_Value_Humidity	2 Bytes
62	Request min./max. humidity measured value	Input	-WC-	[1.17] DPT_Trigger	1 Bit
63	Minimum measured value for humidity	Output	R-CT	[9.7] DPT_Value_Humidity	2 Bytes
64	Maximum measured value for humidity	Output	R-CT	[9.7] DPT_Value_Humidity	2 Bytes
65	Reset min./max. measured value for air humidity	Input	-WC-	[1.17] DPT_Trigger	1 Bit
66	Humidity thresholdV 1: Absolute value	Input / Output	RWC T	[9.7] DPT_Value_Humidity	2 Bytes
67	Humidity thresholdV 1: (1:+   0:-)	Input	-WC-	[1.2] DPT_Bool	1 Bit
68	Humidity thresholdV 1: Switching delay from 0 to 1	Input	-WC-	[7.5] DPT_TimePeriodSec	2 Bytes
69	Humidity thresholdV 1: Switching delay from 1 to 0	Input	-WC-	[7.5] DPT_TimePeriodSec	2 Bytes
70	Humidity thresholdV 1: Switching output	Output	R-CT	[1.1] DPT_Switch	1 Bit
71	Humidity thresholdV 1: Switching output block	Input	-WC-	[1.2] DPT_Bool	1 Bit
72	Humidity thresholdV 2: Absolute value	Input / Output	RWC T	[9.7] DPT_Value_Humidity	2 Bytes
73	Humidity thresholdV 2: (1:+   0:-)	Input	-WC-	[1.2] DPT_Bool	1 Bit
74	Humidity thresholdV 2: Switching delay from 0 to 1	Input	-WC-	[7.5] DPT_TimePeriodSec	2 Bytes
75	Humidity thresholdV 2: Switching delay from 1 to 0	Input	-WC-	[7.5] DPT_TimePeriodSec	2 Bytes
76	Humidity thresholdV 2: Switching output	Output	R-CT	[1.1] DPT_Switch	1 Bit
77	Humidity thresholdV 2: Switching output block	Input	-WC-	[1.2] DPT_Bool	1 Bit
78	Humidity control: Blocking object	Input	-WC-	[1.2] DPT_Bool	1 Bit
79	Humidity control: Target value	Input / Output	RWC T	[9.7] DPT_Value_Humidity	2 Bytes
80	Humidity control: Target value (1:+   0:-)	Input	-WC-	[1.2] DPT_Bool	1 Bit
81	Humidity control: Act. variable dehumidification	Output	R-CT	[5.1] DPT_Scaling	1 Byte
82	Humidity control: Act. variable dehumid. 2nd stage	Output	R-CT	[5.1] DPT_Scaling	1 Byte

No	Text	Function	Flags	DPT type	Size
83	Humidity control: Act. variable humidification	Output	R-CT	[5.1] DPT_Scaling	1 Byte
84	Humidity control: Status dehumidif. (1=ON   0=OFF)	Output	R-CT	[1.1] DPT_Switch	1 Bit
85	Humidity control: Status dehumidif.2 (1=ON 0=OFF)	Output	R-CT	[1.1] DPT_Switch	1 Bit
86	Humidity control: Status humidif. (1=ON   0=OFF)	Output	R-CT	[1.1] DPT_Switch	1 Bit
87	Dew point temperature	Output	R-CT	[9.1] DPT_Value_Temp	2 Bytes
88	Cooling medium temp.: Threshold value	Output	R-CT	[9.1] DPT_Value_Temp	2 Bytes
89	Cooling medium temp.: Actual value	Input	-WC-	[9.1] DPT_Value_Temp	2 Bytes
90	Cooling medium temp.: Offset change (1:+   0:-)	Input	-WC-	[1.2] DPT_Bool	1 Bit
91	Cooling medium temp.: Switching delay from 0 to 1	Input	-WC-	[7.5] DPT_TimePeriodSec	2 Bytes
92	Cooling medium temp.: Switching delay from 1 to 0	Input	-WC-	[7.5] DPT_TimePeriodSec	2 Bytes
93	Cooling medium temp.: Switching output	Output	R-CT	[1.1] DPT_Switch	1 Bit
94	Cooling medium temp.: Switching output block	Input	-WC-	[1.2] DPT_Bool	1 Bit
95	Absolute humidity [g/kg]	Output	R-CT	[14.5] DPT_Value_Amplitude	4 Bytes
96	Absolute humidity [g/m <sup>3</sup> ]	Output	R-CT	[14.17] DPT_Value_Density	4 Bytes
97	Ambient climate: 1=comfortable   0=uncomfortable	Output	R-CT	[1.2] DPT_Bool	1 Bit
98	External VOC measured value	Input	-WC-	[9.8] DPT_Value_AirQuality	2 Bytes
99	Internal VOC measured value	Output	R-CT	[9.8] DPT_Value_AirQuality	2 Bytes
100	Total VOC measured value	Output	R-CT	[9.8] DPT_Value_AirQuality	2 Bytes
101	VOC maximum value request	Input	-WC-	[1.17] DPT_Trigger	1 Bit
102	Maximum VOC measured value	Output	R-CT	[9.8] DPT_Value_AirQuality	2 Bytes
103	Reset VOC maximum value	Input	-WC-	[1.17] DPT_Trigger	1 Bit
104	VOC threshold value 1: Absolute value	Input / Output	RWC T	[9.8] DPT_Value_AirQuality	2 Bytes
105	VOC threshold value 1: (1:+   0:-)	Input	-WC-	[1.2] DPT_Bool	1 Bit

No	Text	Function	Flags	DPT type	Size
106	VOC threshold value 1: Switching delay from 0 to 1	Input	-WC-	[7.5] DPT_TimePeriodSec	2 Bytes
107	VOC threshold value 1: Switching delay from 1 to 0	Input	-WC-	[7.5] DPT_TimePeriodSec	2 Bytes
108	VOC threshold value 1: Switching output	Output	R-CT	[1.1] DPT_Switch	1 Bit
109	VOC threshold value 1: Switch output block	Input	-WC-	[1.2] DPT_Bool	1 Bit
110	VOC threshold value 2: Absolute value	Input / Output	RWC T	[9.8] DPT_Value_AirQuality	2 Bytes
111	VOC threshold value 2: (1:+   0:-)	Input	-WC-	[1.2] DPT_Bool	1 Bit
112	VOC threshold value 2: Switching delay from 0 to 1	Input	-WC-	[7.5] DPT_TimePeriodSec	2 Bytes
113	VOC threshold value 2: Switching delay from 1 to 0	Input	-WC-	[7.5] DPT_TimePeriodSec	2 Bytes
114	VOC threshold value 2: Switching output	Output	R-CT	[1.1] DPT_Switch	1 Bit
115	VOC threshold value 2: Switch output block	Input	-WC-	[1.2] DPT_Bool	1 Bit
116	VOC threshold value 3: Absolute value	Input / Output	RWC T	[9.8] DPT_Value_AirQuality	2 Bytes
117	VOC threshold value 3: (1:+   0:-)	Input	-WC-	[1.2] DPT_Bool	1 Bit
118	VOC threshold value 3: Switching delay from 0 to 1	Input	-WC-	[7.5] DPT_TimePeriodSec	2 Bytes
119	VOC threshold value 3: Switching delay from 1 to 0	Input	-WC-	[7.5] DPT_TimePeriodSec	2 Bytes
120	VOC threshold value 3: Switching output	Output	R-CT	[1.1] DPT_Switch	1 Bit
121	VOC threshold value 3: Switch output block	Input	-WC-	[1.2] DPT_Bool	1 Bit
122	VOC threshold value 4: Absolute value	Input / Output	RWC T	[9.8] DPT_Value_AirQuality	2 Bytes
123	VOC threshold value 4: (1:+   0:-)	Input	-WC-	[1.2] DPT_Bool	1 Bit
124	VOC threshold value 4: Switching delay from 0 to 1	Input	-WC-	[7.5] DPT_TimePeriodSec	2 Bytes
125	VOC threshold value 4: Switching delay from 1 to 0	Input	-WC-	[7.5] DPT_TimePeriodSec	2 Bytes
126	VOC threshold value 4: Switching output	Output	R-CT	[1.1] DPT_Switch	1 Bit
127	VOC threshold value 4: Switch output block	Input	-WC-	[1.2] DPT_Bool	1 Bit
128	VOC controller: Block object	Input	-WC-	[1.2] DPT_Bool	1 Bit
129	VOC controller: Setpoint	Input / Output	RWC T	[9.8] DPT_Value_AirQuality	2 Bytes

No	Text	Function	Flags	DPT type	Size
130	VOC controller: Setpoint (1:+   0:-)	1 = Increment   0 = Decrement	-WC-	[1.2] DPT_Bool	1 Bit
131	VOC controller: Variable ventilation (1st step)	Output	R-CT	[5.1] DPT_Scaling	1 Byte
132	VOC controller: Variable ventilation (2nd step)	Output	R-CT	[5.1] DPT_Scaling	1 Byte
133	VOC controller: Ventilation status (1=ON   0=OFF)	Output	R-CT	[1.1] DPT_Switch	1 Bit
134	VOC controller: Ventilation status 2 (1=ON   0=OFF)	Output	R-CT	[1.1] DPT_Switch	1 Bit
135	Actuating variable comparator 1: Input 1	Input	-WC-	[5.1] DPT_Scaling	1 Byte
136	Actuating variable comparator 1: Input 2	Input	-WC-	[5.1] DPT_Scaling	1 Byte
137	Actuating variable comparator 1: Input 3	Input	-WC-	[5.1] DPT_Scaling	1 Byte
138	Actuating variable comparator 1: Input 4	Input	-WC-	[5.1] DPT_Scaling	1 Byte
139	Actuating variable comparator 1: Input 5	Input	-WC-	[5.1] DPT_Scaling	1 Byte
140	Actuating variable comparator 1: Output	Output	R-CT	[5.1] DPT_Scaling	1 Byte
141	Actuating variable comparator 1: Block	Output	-WC-	[1.2] DPT_Bool	1 Bit
142	Actuating variable comparator 2: Input 1	Input	-WC-	[5.1] DPT_Scaling	1 Byte
143	Actuating variable comparator 2: Input 2	Input	-WC-	[5.1] DPT_Scaling	1 Byte
144	Actuating variable comparator 2: Input 3	Input	-WC-	[5.1] DPT_Scaling	1 Byte
145	Actuating variable comparator 2: Input 4	Input	-WC-	[5.1] DPT_Scaling	1 Byte
146	Actuating variable comparator 2: Input 5	Input	-WC-	[5.1] DPT_Scaling	1 Byte
147	Actuating variable comparator 2: Output	Output	R-CT	[5.1] DPT_Scaling	1 Byte
148	Actuating variable comparator 2: Block	Output	-WC-	[1.2] DPT_Bool	1 Bit
149	AND logic 1: 1 bit switching output	Output	R-CT	[1.1] DPT_Switch	1 Bit
150	AND logic 1: 8 bit output A	Output	R-CT	[5] 5.xxx	1 Byte
151	AND logic 1: 8 bit output B	Output	R-CT	[5] 5.xxx	1 Byte

No	Text	Function	Flags	DPT type	Size
152	AND logic 1: Switching output block	Input	-WC-	[1.2] DPT_Bool	1 Bit
153	AND logic 2: 1 bit switching output	Output	R-CT	[1.1] DPT_Switch	1 Bit
154	AND logic 2: 8 bit output A	Output	R-CT	[5] 5.xxx	1 Byte
155	AND logic 2: 8 bit output B	Output	R-CT	[5] 5.xxx	1 Byte
156	AND logic 2: Switching output block	Input	-WC-	[1.2] DPT_Bool	1 Bit
157	AND logic 3: 1 bit switching output	Output	R-CT	[1.1] DPT_Switch	1 Bit
158	AND logic 3: 8 bit output A	Output	R-CT	[5] 5.xxx	1 Byte
159	AND logic 3: 8 bit output B	Output	R-CT	[5] 5.xxx	1 Byte
160	AND logic 3: Switching output block	Input	-WC-	[1.2] DPT_Bool	1 Bit
161	AND logic 4: 1 bit switching output	Output	R-CT	[1.1] DPT_Switch	1 Bit
162	AND logic 4: 8 bit output A	Output	R-CT	[5] 5.xxx	1 Byte
163	AND logic 4: 8 bit output B	Output	R-CT	[5] 5.xxx	1 Byte
164	AND logic 4: Switching output block	Input	-WC-	[1.2] DPT_Bool	1 Bit
181	OR logic 1: 1 bit switching output	Output	R-CT	[1.1] DPT_Switch	1 Bit
182	OR logic 1: 8 bit output A	Output	R-CT	[5] 5.xxx	1 Byte
183	OR logic 1: 8 bit output B	Output	R-CT	[5] 5.xxx	1 Byte
184	OR logic 1: Switching output block	Input	-WC-	[1.2] DPT_Bool	1 Bit
185	OR logic 2: 1 bit switching output	Output	R-CT	[1.1] DPT_Switch	1 Bit
186	OR logic 2: 8 bit output A	Output	R-CT	[5] 5.xxx	1 Byte
187	OR logic 2: 8 bit output B	Output	R-CT	[5] 5.xxx	1 Byte
188	OR logic 2: Switching output block	Input	-WC-	[1.2] DPT_Bool	1 Bit
189	OR logic 3: 1 bit switching output	Output	R-CT	[1.1] DPT_Switch	1 Bit
190	OR logic 3: 8 bit output A	Output	R-CT	[5] 5.xxx	1 Byte
191	OR logic 3: 8 bit output B	Output	R-CT	[5] 5.xxx	1 Byte
192	OR logic 3: Switching output block	Input	-WC-	[1.2] DPT_Bool	1 Bit
193	OR logic 4: 1 bit switching output	Output	R-CT	[1.1] DPT_Switch	1 Bit
194	OR logic 4: 8 bit output A	Output	R-CT	[5] 5.xxx	1 Byte
195	OR logic 4: 8 bit output B	Output	R-CT	[5] 5.xxx	1 Byte
196	OR logic 4: Switching output block	Input	-WC-	[1.2] DPT_Bool	1 Bit
200	Logic input 1	Input	-WC-	[1.2] DPT_Bool	1 Bit
201	Logic input 2	Input	-WC-	[1.2] DPT_Bool	1 Bit
202	Logic input 3	Input	-WC-	[1.2] DPT_Bool	1 Bit
203	Logic input 4	Input	-WC-	[1.2] DPT_Bool	1 Bit
204	Logic input 5	Input	-WC-	[1.2] DPT_Bool	1 Bit
205	Logic input 6	Input	-WC-	[1.2] DPT_Bool	1 Bit
206	Logic input 7	Input	-WC-	[1.2] DPT_Bool	1 Bit
207	Logic input 8	Input	-WC-	[1.2] DPT_Bool	1 Bit

No	Text	Function	Flags	DPT type	Size
208	Logic input 9	Input	-WC-	[1.2] DPT_Bool	1 Bit
209	Logic input 10	Input	-WC-	[1.2] DPT_Bool	1 Bit
210	Logic input 11	Input	-WC-	[1.2] DPT_Bool	1 Bit
211	Logic input 12	Input	-WC-	[1.2] DPT_Bool	1 Bit
212	Logic input 13	Input	-WC-	[1.2] DPT_Bool	1 Bit
213	Logic input 14	Input	-WC-	[1.2] DPT_Bool	1 Bit
214	Logic input 15	Input	-WC-	[1.2] DPT_Bool	1 Bit
215	Logic input 16	Input	-WC-	[1.2] DPT_Bool	1 Bit
220	Display contrast (1 = higher   0 = lower)	Input	-WC-	[1.1] DPT_Switch	1 Bit
221	Display lighting (1 = on   0 = off)	Input	-WC-	[1.1] DPT_Switch	1 Bit
222	Display lighting Brightness	Input	RWC T	[5.1] DPT_Scaling	1 Byte
223	Display lighting Switch off delay	Input	RWC T	[7.5] DPT_TimePeriodSec	2 Bytes
230	Date for display	Input	-WCT	[11.1] DPT_Date	3 Bytes
231	Time for display	Input	-WCT	[10.1] DPT_TimeOfDay	3 Bytes
232	8 bit object 1 for display	Input	-WC-	[5] 5.xxx	1 Byte
233	8 bit object 2 for display	Input	-WC-	[5] 5.xxx	1 Byte
234	8 bit object 3 for display	Input	-WC-	[5] 5.xxx	1 Byte
235	16 bit object 1 for display	Input	-WC-	[9] 9.xxx	2 Bytes
236	16 bit object 2 for display	Input	-WC-	[9] 9.xxx	2 Bytes
237	Text message 1 for display	Input	-WC-	[16.0] DPT_String_ASCII	14 Bytes
238	Text message 2 for display	Input	-WC-	[16.0] DPT_String_ASCII	14 Bytes
239	Back jump release for display	Input	-WC-	[1.1] DPT_Switch	1 Bit
240	Push button 1 long-term	Output	R-CT	[1.8] DPT_UpDown	1 Bit
241	Push button 1 short-term	Output	R-CT	[1.10] DPT_Start	1 Bit
242	Push button 1 switching	Output	R-CT	[1.1] DPT_Switch	1 Bit
243	Push button 1 dimming	Input / Output	RWC T	[3.7] DPT_Control_Dimming	4 Bit
244	Push button 1 encoder 8 bit	Output	R-CT	[5] 5.xxx	1 Byte
245	Push button 1 encoder 16 bit	Output	R-CT	[9] 9.xxx	2 Bytes
246	Push button 1 scene	Output	R-CT	[5] 5.xxx	1 Byte
247	Push button 2 long-term	Output	R-CT	[1.8] DPT_UpDown	1 Bit
248	Push button 2 short-term	Output	R-CT	[1.10] DPT_Start	1 Bit
249	Push button 2 switching	Output	R-CT	[1.1] DPT_Switch	1 Bit
250	Push button 2 dimming	Input / Output	RWC T	[3.7] DPT_Control_Dimming	4 Bit



No	Text	Function	Flags	DPT type	Size
251	Push button 2 encoder 8 bit	Output	R-CT	[5] 5.xxx	1 Byte
252	Push button 2 encoder 16 bit	Output	R-CT	[9] 9.xxx	2 Bytes
253	Push button 2 scene	Output	R-CT	[5] 5.xxx	1 Byte

## 6. Parameter setting

### 6.1. Behaviour on power failure/ restoration of power

#### **Behaviour following a failure of the bus power supply:**

The device sends nothing.

#### **Behaviour on bus restoration of power and following programming or reset:**

The device sends all outputs according to their send behaviour set in the parameters with the delays established in the "General settings" parameter block.

### 6.2. General settings

Set the basic data transfer characteristics and select whether or not malfunction objects should be sent.

Send delay after power-up and programming for:	
Measured values	<u>5 s</u> • ... • 2 h
Threshold values and switching outputs	<u>5 s</u> • ... • 2 h
Controller objects	5 s • <u>10 s</u> • ... • 2 h
Logic outputs	5 s • <u>10 s</u> • ... • 2 h
Maximum telegram quota	<ul style="list-style-type: none"> <li>• 1 message per second</li> <li>• ...</li> <li>• <u>5 messages per second</u></li> <li>• ...</li> <li>• 20 messages per second</li> </ul>

Activate the malfunction objects for temperature/humidity or VOC to receive information on the bus if something is wrong with the measurement.

Use temp./humidity malfunction object	Yes • <u>No</u>
Use VOC malfunction object	Yes • <u>No</u>

### 6.3. Temperature value

Use **Offsets** to adjust the readings to be sent.

Offset in 0,1°C	-50...50; <u>0</u>
-----------------	--------------------

The unit can calculate a **mixed value** from its own reading and an external value. Set the mixed value calculation if desired. If an external value is used, all of the following settings are referred to the total value.

Use external reading	Yes • <u>No</u>
Ext. Reading proportion of the total reading	5% • 10% • ... • <u>50%</u> • ... • 100%
All of the following settings are referred to the total value.	
Send internal and total reading	<ul style="list-style-type: none"> <li>• <u>never</u></li> <li>• periodically</li> <li>• on change</li> <li>• on change and periodically</li> </ul>
From change of (if sent on change)	<u>0,1°C</u> • 0,2°C • 0,5°C • ... • 5,0°C
Send cycle (if sent periodically)	<u>5 s</u> • 10 s • ... • 2 h

The **minimum and maximum readings** can be saved and sent to the bus. Use the „Reset temperature min/max. value“ objects to reset the values to the current readings. The values are not retained after a reset.

Use minimum/maximum value	Yes • <u>No</u>
---------------------------	-----------------

## 6.4. Temperature threshold values

Activate the required temperature threshold values. The menus for setting the threshold values are displayed.

Use threshold value 1/2/3	Yes • <u>No</u>
---------------------------	-----------------

### 6.4.1. Threshold value 1, 2, 3

#### Threshold value

Set, in which cases **threshold values** received via object are to be retained. The parameter is only taken into consideration if the setting via object is activated below. Please note that the setting "After power supply restoration and programming" should not be used for the initial start-up, as the factory settings are always used until the first communication (setting via objects is ignored).

Set the threshold value directly in the application program using parameters, or define them via the bus using a communication object.

#### **Threshold value setting via parameter:**

Set the threshold values and hysteresis directly.

Threshold value setting via	<b>Parameter</b> • Communication objects
Threshold value in 0.1°C	-300 ... 800; <u>200</u>

### Threshold value setting via a communication object:

Define, how the threshold value is to be received from the bus. Basically, a new value can be received, or simply a command to increase or decrease.

During initial commissioning, a threshold value must be defined, which will be valid until the first communication with a new threshold value. For units which have already been taken into service, the last communicated threshold value can be used. Basically, a temperature range is given, in which the threshold value can be changed (object value limit).

A set threshold value will be retained until a new value or a change is transferred. The current value is saved, so that it is retained in the event of a power supply failure and will be available once the power supply is restored.

Threshold value setting via	Parameter • <b>Communication objects</b>
The value communicated last shall be maintained	<ul style="list-style-type: none"> <li>• <u>never</u></li> <li>• after power supply restoration</li> <li>• after power supply restoration and programming</li> </ul>
Start threshold value in 0.1°C valid until first communication	-300 ... 800; <u>200</u>
Object value limit (min) in 0.1°C	<u>-300</u> ...800
Object value limit (max) in 0.1°C	-300... <u>800</u>
Type of threshold value change	<u>Absolute value</u> • Increase/decrease
Increment (upon increase/decrease change)	0,1 °C • ... • 5°C, <u>1°C</u>

Set the **hysteresis** independent of the type of threshold value specification.

Hysteresis in % of the threshold value	0 ... 50; <u>20</u>
--	---------------------

### Switching output

Set the behaviour of the switching output when a threshold value is exceeded/undercut. The output switching delay can be set using objects or directly as a parameter.

When the following conditions apply, the output is (TV = Threshold value)	<ul style="list-style-type: none"> <li>• <u>TV above = 1   TV - hyst. below = 0</u></li> <li>• <u>TV above = 0   TV - hyst. below = 1</u></li> <li>• <u>TV below = 1   TV + hyst. above = 0</u></li> <li>• <u>TV below = 0   TV + hyst. above = 1</u></li> </ul>
Delays can be set via objects (in seconds)	<u>No</u> • Yes
Switching delay from 0 to 1 (If delay can be set via objects: valid until 1st communication)	<u>None</u> • 1 s • 2 s • 5 s • 10 s • ... • 2 h
Switching delay from 1 to 0 (If delay can be set via objects: valid until 1st communication)	<u>None</u> • 1 s • 2 s • 5 s • 10 s • ... • 2 h

Switching output sends	<ul style="list-style-type: none"> <li>• <u>on change</u></li> <li>• on change to 1</li> <li>• on change to 0</li> <li>• on change and periodically</li> <li>• on change to 1 and periodically</li> <li>• on change to 0 and periodically</li> </ul>
Cycle (only if sending periodically is selected)	<u>5</u> s • 10 s • 30 s... • 2 h

## Block

The switching output can be blocked using an object.

Use switching output block	<u>No</u> • Yes
----------------------------	-----------------

If the block is activated, define specifications here for the behaviour of the output when blocked.

Analysis of the blocking object	<ul style="list-style-type: none"> <li>• <u>At value 1: block   At value 0: release</u></li> <li>• At value 0: block   At value 1: release</li> </ul>
Blocking object value before 1st communication	<u>0</u> • 1
Behaviour of the switching output	
On block	<ul style="list-style-type: none"> <li>• <u>Do not send message</u></li> <li>• send 0</li> <li>• send 1</li> </ul>
On release (with 2 seconds release delay)	[Dependent on the "Switching output sends" setting]

The behaviour of the switching output on release is dependent on the value of the parameter "Switching output sends" (see "Switching output")

Switching output sends on change	<ul style="list-style-type: none"> <li>• Do not send message</li> <li>• Send switching output status</li> </ul>
Switching output sends on change to 1	<ul style="list-style-type: none"> <li>• Do not send message</li> <li>• if switching output = 1 → send 1</li> </ul>
Switching output sends on change to 0	<ul style="list-style-type: none"> <li>• Do not send message</li> <li>• if switching output = 0 → send 0</li> </ul>
Switching output sends on change and periodically	Send switching output status
Switching output sends on change to 1 and periodically	if switching output = 1 → send 1
Switching output sends on change to 0 and periodically	if switching output = 0 → send 0

## 6.5. Temperature PI control

Activate the control if you want to use it.

Use control	<u>No</u> • Yes
-------------	-----------------

## General control

Set, in which cases **setpoint values and extension time** received via object are to be retained. The parameter is only taken into consideration if the setting via object is activated below. Please note that the setting "After power supply restoration and programming" should not be used for the initial start-up, as the factory settings are always used until the 1st communication (setting via objects is ignored).

For an adequate regulation of the indoor temperature, comfort, standby, eco and building protection modes may be used.

**Comfort** when present,

**Standby** during short absences,

**Eco** as a night-time mode and

**Frost/heat protection** (building protection) during longer absences.

The settings for the temperature control include the set point temperatures for the individual modes. Objects are used to determine which mode is to be selected. A change of mode may be triggered manually or automatically (e.g. by a timer, window contact).

The **mode** may be switched with two 8 bit objects of different priority. Objects

„... HVAC mode (Prio 2)“ for switching in everyday operation and

„... HVAC mode (Prio 1)“ for central switching with higher priority.

The objects are coded as follows:

0 = Auto

1 = Comfort

2 = Standby

3 = Eco

4 = Building Protection

Alternatively, you can use three objects, with one object switching between eco and standby mode and the two others activating comfort mode and frost/heat protection mode respectively. The comfort object blocks the eco/standby object, and the frost/heat protection object has the highest priority. Objects

„... Mode (1: Eco, 0: Standby)“,

„... comfort activation mode“ and

„... frost/heat protection activation mode“

Switch mode via	<ul style="list-style-type: none"> <li>• two 8 Bit objects (HVAC Modes)</li> <li>• three 1 bit objects</li> </ul>
-----------------	---



Select the **mode to be activated after reset** (e.g. power failure, reset of the line via the bus) (Default).

Then configure a temperature control **block** via the blocking object.

Mode after reset	<ul style="list-style-type: none"> <li>• Comfort</li> <li>• <u>Standby</u></li> <li>• <u>Eco</u></li> <li>• Building protection</li> </ul>
------------------	--

Behaviour of the blocking object with value	<ul style="list-style-type: none"> <li>• <u>1 = Block</u>   0 = release</li> <li>• 0 = block   1 = release</li> </ul>
Blocking object value before 1st communication	<u>0</u> • 1

Specify when the current **control variables** of the controller are to be **sent** to the bus. Periodic sending is safer, in case a message does not reach a recipient. You may also set up periodical monitoring by the actuator with this setting.

Send control variable	<ul style="list-style-type: none"> <li>• <u>on change</u></li> <li>• on change and periodically</li> </ul>
from change (in % absolute)	1...10; <u>2</u>
Cycle (if sent periodically)	5 s • ... • <u>5 min</u> • ... • 2 h

The **status object** reports the current status of the control variables (0% = OFF, >0% = ON) and may for example be used for visualisation, or to switch off the heating pump as soon as the heating is switched off.

Send status objects	<ul style="list-style-type: none"> <li>• <u>on change</u></li> <li>• on change to 1</li> <li>• on change to 0</li> <li>• on change and periodically</li> <li>• on change to 1 and periodically</li> <li>• on change to 0 and periodically</li> </ul>
Cycle (if sent periodically)	5 s • ... • <u>5 min</u> • ... • 2 h

Then define the **type of control**. Heating and/or cooling may be controlled in two levels.

Type of control	<ul style="list-style-type: none"> <li>• <u>Single level heating</u></li> <li>• Dual-level heating</li> <li>• Single-level cooling</li> <li>• Single-level heating + single-level cooling</li> <li>• Dual-level heating + single-level cooling</li> <li>• Dual-level heating + dual-level cooling</li> </ul>
-----------------	--

## General set point values

You may enter separate set point values for each mode or use the comfort set point as a basic value.

If you are using the controls for both heating *and* cooling, you may also select the setting "separately with switching object". Systems used for cooling in the summer and for heating in the winter can thus be switched from one to the other.

If you are using the basic value, only the deviation from the comfort set point value is listed for the other modes (e. g., 2°C less for standby mode).

Preserve modified set points after mode change	No • <u>Yes</u>
Setting the nominal values	<ul style="list-style-type: none"> <li>• <u>separate with switching object</u></li> <li>• separate without switching object</li> <li>• with comfort set point as a basis with switching object</li> <li>• with comfort set point as a basis without switching object</li> </ul>
Behaviour of the switching object at value <i>only if switching object is used</i>	<ul style="list-style-type: none"> <li>• <u>0 = Heating   1 = Cooling</u></li> <li>• 1 = Heating   0 = Cooling</li> </ul>
Switching object value before 1st communication <i>only if switching object is used</i>	<u>0</u> • 1

The grades for the set point changes is predefined. Modifications may only remain active temporarily (do not save) or remain saved even after voltage recovery (and programming). This also applies to a comfort extension.

Grading for set point changes (in 0.1 °C)	1... 50; <u>10</u>
Saving set point value(s)	<ul style="list-style-type: none"> <li>• not</li> <li>• <u>after voltage recovery</u></li> <li>• after voltage recovery and programming</li> </ul>

The control may be manually reset to comfort mode from eco, or night mode. This allows the user to maintain the daily nominal value for a longer time, e.g. when having guests. The duration of this comfort extension period is set. After the comfort extension period is terminated, the system returns to eco mode.

Comfort extension time in seconds (can only be activated from eco mode)	1...36000; <u>3600</u>
---	------------------------

## Set point Comfort

Comfort mode is usually used for daytime mode when people are present. A starting value is defined for the comfort set point as well as a temperature range in which the nominal value may be modified.

Initial heating/cooling set point (in 0.1 °C) valid till 1st communication <i>not upon saving the set point value after programming</i>	-300...800; <u>210</u>
---	------------------------

### ***If set point values are entered separately:***

Min. object value heating/cooling (in 0.1 °C)	-300...800; <u>160</u>
Max. object value heating/cooling (in 0.1 °C)	-300...800; <u>280</u>

### ***If the comfort setpoint value is used as a basis:***

If the comfort setpoint value is used as a basis, the reduction/increment of the value is set.

Starting heating/cooling setpoint (in 0.1 °C) valid until 1st communication	-300...800; <u>210</u>
Minimum base setpoint (in 0.1°C)	-300...800; <u>160</u>
Maximum base setpoint (in 0.1°C)	-300...800; <u>280</u>
Reduction by up to (in 0.1°C)	1...100; <u>50</u>
Increase by up to (in 0.1°C)	1...100; <u>50</u>

If the comfort setpoint is used as the basis without a switching object, a dead zone is specified for the control mode "heating *and* cooling" to avoid direct switching from heating to cooling.

Dead zone between heating and cooling in 0,1°C <i>(only if both heating AND cooling are used)</i>	1...100; <u>50</u>
--	--------------------

## Standby setpoint

Standby mode is usually used for daytime mode when people are absent.

### ***If setpoint values are entered separately:***

A starting setpoint value is defined as well as a temperature range in which the setpoint value may be changed.

Starting heating setpoint (in 0.1 °C) valid until 1st communication	-300...800; <u>180</u>
Starting heating setpoint (in 0.1 °C) valid until 1st communication	-300...800; <u>240</u>



Min. object value heating/cooling (in 0.1 °C)	-300...800; <u>160</u>
Max. object value heating/cooling (in 0.1 °C)	-300...800; <u>280</u>

**If the comfort setpoint value is used as a basis:**

If the comfort setpoint value is used as a basis, the reduction/increment of the value is set.

Reduce heating setpoint (in 0.1°C) (for heating)	0...200; <u>30</u>
Increase cooling setpoint (in 0.1°C) (for cooling)	0...200; <u>30</u>

## Eco setpoint

Eco mode is usually used for night mode.

**If setpoint values are entered separately:**

A starting setpoint value is defined as well as a temperature range in which the setpoint value may be changed.

Starting heating setpoint (in 0.1 °C) valid until 1st communication	-300...800; <u>160</u>
Starting cooling setpoint (in 0.1 °C) valid until 1st communication	-300...800; <u>280</u>
Min. object value heating/cooling (in 0.1 °C)	-300...800; <u>160</u>
Max. object value heating/cooling (in 0.1 °C)	-300...800; <u>280</u>

**If the comfort setpoint value is used as a basis:**

If the comfort setpoint value is used as a basis, the reduction/increment of the value is set.

Reduce heating setpoint (in 0.1°C) (for heating)	0...200; <u>50</u>
Increase cooling setpoint (in 0.1°C) (for cooling)	0...200; <u>60</u>

## Setpoint values for frost/heat protection (building protection)

The building protection mode is for example used as long as windows are opened for ventilation. Setpoints for frost protection (heating) and heat protection (cooling) are determined which may not be modified from outside (no access via operating devices etc.). The building protection mode may be activated with delay, which allows you to leave the building before the controls switch to frost/heat protection mode.

Setpoint frost protection (in 0.1°C)	-300...800; <u>70</u>
Activation delay	none • 5 s • ... • <u>5 min</u> • ... • 2 h

Setpoint heat protection (in 0.1°C)	-300...800; <u>350</u>
Activation delay	none • 5 s • ... • <u>5 min</u> • ... • 2 h

## General control variables

This setting appears for the control types "Heating *and* Cooling" only. Here, you can decide whether to use a common control variable for heating and cooling. If the 2nd level has a common control variable, you also determine the control mode of the 2nd level here.

For heating and cooling	<ul style="list-style-type: none"> <li>• <u>separate control variables are used</u></li> <li>• common control variables are used for Level 1</li> <li>• common control variables are used for Level 2</li> <li>• common control variable are used for Level 1+2</li> </ul>
Use control variable for 4/6-way valve (only for common control variables in level 1)	<u>No</u> • Yes
Control type (for level 2 only)	<ul style="list-style-type: none"> <li>• 2-point-control</li> <li>• PI control</li> </ul>
Control variable of the 2nd Level is on (only for level 2 with 2 point controlling)	<ul style="list-style-type: none"> <li>• <u>1 bit object</u></li> <li>• 8 bit object</li> </ul>

When using the control variable for a 4/6 way valve, the following applies:

0%...100% heating = 66%...100% control variable

OFF = 50% control variable

0%...100% cooling = 33%...0% control variable

### 6.5.1. Heating control level 1/2

If a heating control mode is configured, one or two setting sections for the heating levels are displayed.

In the 1st level, heating is controlled by a PI control, which allows to either enter control parameters or select predetermined applications.

In the 2nd level (therefore only in case of 2-level heating), heating is controlled via a PI or a 2-point-control.

In level 2, the setpoint difference between the two levels must also be specified, i.e. below which setpoint deviation the second level is added.

Setpoint difference between 1st and 2nd level (in 0.1°C) (for level 2)	0...100; <u>40</u>
Control type (for level 2, no common control variables)	<ul style="list-style-type: none"> <li>• 2-point-control</li> <li>• PI control</li> </ul>

Control variable is a (for level 2 with 2-point controlling, no common control variables)	<ul style="list-style-type: none"> <li>• 1 bit object</li> <li>• 8 bit object</li> </ul>
--	--

### **PI control with control parameters:**

This setting allows individual input of the parameters for PI control.

Control type	<ul style="list-style-type: none"> <li>• <b>PI control</b></li> </ul>
Setting of the controller by	<ul style="list-style-type: none"> <li>• <b>Controller parameter</b></li> <li>• specified applications</li> </ul>

Specify the deviation from the setpoint value at which the maximum control variable value is reached, i.e. the point at which maximum heating power is activated.

The reset time shows how quickly the controller responds to deviations from the setpoint value. In case of a short reset time, the control responds with a fast increase of the control variable. In case of a long reset time, the control responds somewhat less urgently and needs longer until the necessary control variable for the setpoint value deviation is reached.

You should set the time appropriate to the heating system at this point (observe manufacturer's instructions).

Maximum control variable is reached at setpoint/actual difference of (in °C)	1... <u>5</u>
Reset time (in min.)	1...255; <u>30</u>

Now specify what should be sent when the control is blocked. Set a value greater 0 (=OFF) to receive a basic heating level, e.g. for floor heating.

On release, the control variable follows the rule again.

When blocked, the control variable shall	<ul style="list-style-type: none"> <li>• <u>not be sent</u></li> <li>• send a specific value</li> </ul>
Value (in %) (if a value is sent)	<u>0</u> ...100

In case of a common control variable for heating and cooling, 0 is always transmitted as a fixed value.

### **PI control with predetermined application:**

This setting provides fixed parameters for frequent applications.

Control type	<ul style="list-style-type: none"> <li>• <b>PI control</b></li> </ul>
Setting of the controller by	<ul style="list-style-type: none"> <li>• Controller parameter</li> <li>• <b>specified applications</b></li> </ul>
Application	<ul style="list-style-type: none"> <li>• Warm water heating</li> <li>• Floor heating</li> <li>• Convection unit</li> <li>• Electric heating</li> </ul>
Maximum control variable is reached at setpoint/actual difference of (in °C)	Warm water heating: 5 Floor heating: 5 Convection unit: 4 Electric heating: 4

Reset time (in min.)	Warm water heating: 150 Floor heating: 240 Convection unit: 90 Electric heating: 100
----------------------	---

Now specify what should be sent when the control is blocked. Set a value greater 0 (=OFF) to receive a basic heating level, e.g. for floor heating.

On release, the control variable follows the rule again.

When blocked, the control variable shall	<ul style="list-style-type: none"> <li>• not be sent</li> <li>• send a specific value</li> </ul>
Value (in %) (if a value is sent)	<u>0</u> ...100

In case of a common control variable for heating and cooling, 0 is always transmitted as a fixed value.

### 2-point-control (only level 2):

2-point-control is used for systems which are only set to ON or OFF.

Control type (is determined at a higher level for common control variables)	<ul style="list-style-type: none"> <li>• <b>2-point-control</b></li> </ul>
--	--

Enter the hysteresis that prevents frequent on/off switching of temperatures in the threshold range.

Hysteresis (in 0.1°C)	0...100; <u>20</u>
-----------------------	--------------------

If separate control variables are used, select whether the control variable of the 2nd level is a 1 bit object (on/off) or an 8 bit object (on with percentage/off).

Control variable is a	<ul style="list-style-type: none"> <li>• <u>1 bit object</u></li> <li>• 8 bit object</li> </ul>
Value (in %) (for 8 bit object)	0... <u>100</u>

Now specify what should be sent when the control is blocked. Set a value greater 0 (=OFF) to receive a basic heating level, e.g. for floor heating. On release, the control variable follows the rule again.

When blocked, the control variable shall	<ul style="list-style-type: none"> <li>• not be sent</li> <li>• send a specific value</li> </ul>
Value (in %) only if a value is sent	<u>0</u> ...100

## 6.5.2. Cooling control level 1/2

If a cooling control mode is configured, one or two setting sections for the cooling levels are displayed.

In the 1st level, cooling is controlled by a PI control in which either control parameters can be entered or predetermined applications can be selected.

In the 2nd level (therefore only for 2-level cooling), cooling is controlled via a PI or a 2-point-control.

In level 2, the setpoint deviation between the two levels must also be specified, i.e. above which setpoint value deviation the second level is added.

Setpoint difference between 1st and 2nd level (in 0.1°C) <i>(for level 2)</i>	0...100; <u>40</u>
Control type <i>(for level 2, no common control variables)</i>	<ul style="list-style-type: none"> <li>• 2-point-control</li> <li>• PI control</li> </ul>
Control variable is a <i>(for level 2 with 2-point controlling, no common control variables)</i>	<ul style="list-style-type: none"> <li>• <u>1 bit object</u></li> <li>• 8 bit object</li> </ul>

### **PI control with control parameters:**

This setting allows individual input of the parameters for PI control.

Control type	• <b>PI control</b>
Setting of the controller by	<ul style="list-style-type: none"> <li>• <b>Controller parameter</b></li> <li>• specified applications</li> </ul>

Specify the deviation from the setpoint value which reaches maximum variable value, i.e. the point at which maximum cooling power is activated.

The reset time shows how quickly the controller responds to deviations from the setpoint value. In case of a short reset time, the control responds with a fast increase of the control variable. In case of a long reset time, the control responds somewhat less urgently and needs longer until the necessary control variable for the setpoint value deviation is reached. You should set the time appropriate to the cooling system at this point (observe manufacturer's instructions).

Maximum control variable is reached at setpoint/actual difference of (in °C)	1... <u>5</u>
Reset time (in min.)	1...255; <u>30</u>

Now specify what should be sent when the control is blocked.

On release, the control variable follows the rule again.

When blocked, the control variable shall	<ul style="list-style-type: none"> <li>• <u>not be sent</u></li> <li>• send a specific value</li> </ul>
Value (in %) <i>(if a value is sent)</i>	<u>0</u> ...100

In case of a common control variable for heating and cooling, 0 is always transmitted as a fixed value.

### **PI control with predetermined application:**

This setting provides fixed parameters for a cooling ceiling

Control type	• <b>PI control</b>
Setting of the controller by	<ul style="list-style-type: none"> <li>• Controller parameter</li> <li>• <b>specified applications</b></li> </ul>

Application	• Cooling ceiling
Maximum control variable is reached at setpoint/actual difference of (in °C)	Cooling ceiling: 5
Reset time (in min.)	Cooling ceiling: 30

Now specify what should be sent when the control is blocked.  
On release, the control variable follows the rule again.

When blocked, the control variable shall	<ul style="list-style-type: none"> <li>• not be sent</li> <li>• send a specific value</li> </ul>
Value (in %) (if a value is sent)	<u>0</u> ...100

### **2-point-control (only level 2):**

2-point-control is used for systems which are only set to ON or OFF.

Control type <i>is determined at a higher level for common variables</i>	• <b>2-point-control</b>
---	--------------------------

Enter the hysteresis that prevents frequent on/off switching of temperatures in the threshold range.

Hysteresis (in 0.1°C)	0...100; <u>20</u>
-----------------------	--------------------

If separate control variables are used, select whether the control variable of the 2nd level is a 1 bit object (on/off) or an 8 bit object (on with percentage/off).

Control variable is a	<ul style="list-style-type: none"> <li>• <u>1 bit object</u></li> <li>• 8 bit object</li> </ul>
Value (in %) (for 8 bit object)	0... <u>100</u>

Now specify what should be sent when the control is blocked.  
On release, the control variable follows the rule again.

When blocked, the control variable shall	<ul style="list-style-type: none"> <li>• <u>not be sent</u></li> <li>• send a specific value</li> </ul>
Value (in %) (if a value is sent)	<u>0</u> ...100

In case of a common control variable for heating and cooling, 0 is always transmitted as a fixed value.

## **6.6. Humidity measurement**

Use **Offsets** to adjust the readings to be sent.

Offset in % RH	-10...10; <u>0</u>
----------------	--------------------

The unit can calculate a **mixed value** from its own reading and an external value. Set the mixed value calculation if desired. If an external portion is used, all of the following settings (threshold values, etc.) are related to the overall reading.

Use external measured value	<u>No</u> • Yes
Ext. Reading proportion of the total reading	5% • 10% • ... • <u>50%</u> • ... • 100%
All of the following settings are referred to the total value.	
Send internal and total reading	<ul style="list-style-type: none"> <li>• <u>never</u></li> <li>• periodically</li> <li>• on change</li> <li>• on change and periodically</li> </ul>
At and above change of (if sent on change)	0.1% RH • 0.2% RH • 0.5% RH • <u>1.0% RH</u> • ... • 25% RH
Send cycle (if sent periodically)	<u>5 s</u> • 10 s • ... • 2 h

The **minimum and maximum readings** can be saved and sent to the bus. Use the „Reset humidity min/max value“ object to reset the values to the current readings. The values are not retained after a reset.

Use minimum and maximum value	<u>No</u> • Yes
-------------------------------	-----------------

## 6.7. Humidity threshold values

Activate the required air humidity threshold values. The menus for setting the threshold values are displayed.

Use threshold value 1/2	Yes • <u>No</u>
-------------------------	-----------------

### 6.7.1. Threshold value 1, 2

#### Threshold value

Set, in which cases **threshold values and delay times** received via objects are to be retained. The parameter is only taken into consideration if the setting via object is activated below. Please note that the setting "After power supply restoration and programming" should not be used for the initial start-up, as the factory settings are always used until the first communication (setting via objects is ignored).

Set the threshold value directly in the application program using parameters, or define them via the bus using a communication object.

#### **Threshold value setting using parameter:**

Set the threshold values and hysteresis directly.

Threshold value setting using	<b>Parameter</b> • Communication objects
Threshold value in 0.1% RH (valid until 1st communication)	0 ... 100; <u>70</u>

### Threshold value setting using a communication object:

Define, how the threshold value is to be received from the bus. Basically, a new value can be received, or simply a command to increase or decrease.

During initial commissioning, a threshold value must be defined, which will be valid until the first communication with a new threshold value. For units which have already been taken into service, the last communicated threshold value can be used. Basically, a humidity range is specified in which the threshold value can be changed (object value limit).

A set threshold value will be retained until a new value or a change is transferred. The current value is saved, so that it is retained in the event of a power supply failure and will be available once the power supply is restored.

Threshold value setting using	Parameter • <b>Communication objects</b>
The value communicated last shall be maintained	<ul style="list-style-type: none"> <li>• <u>never</u></li> <li>• after power supply restoration</li> <li>• after power supply restoration and programming</li> </ul>
Starting threshold value in 0.1% RH valid until first communication	0 ... 100; <u>70</u>
Object value limit (min.) in 0.1%RH	<u>0</u> ...100
Object value limit (max.) in 0.1%RH	0... <u>100</u>
Type of threshold value change	<u>Absolute value</u> • Increase/Decrease
Increment (upon increase/decrease change)	1,00% • <u>2,00%</u> • 5,00% • 10,00%

Set the **hysteresis** independent of the type of threshold value specification.

Hysteresis of the threshold value in % (relative to the threshold value)	0 ... 50; <u>20</u>
---	---------------------

### Switching output

Set the behaviour of the switching output when a threshold value is exceeded/undercut. The output switching delay can be set using objects or directly as a parameter.

When the following conditions apply, the output is (TV = Threshold value)	<ul style="list-style-type: none"> <li>• <u>TV above = 1</u>   TV - hyst. below = 0</li> <li>• <u>TV above = 0</u>   TV - hyst. below = 1</li> <li>• TV below = 1   TV + hyst. above = 0</li> <li>• TV below = 0   TV + hyst. above = 1</li> </ul>
Delays can be set via objects (in seconds)	<u>No</u> • Yes
Switching delay from 0 to 1 (If delay can be set via objects: valid until 1st communication)	<u>None</u> • 1 s • 2 s • 5 s • 10 s • ... • 2 h
Switching delay from 1 to 0 (If delay can be set via objects: valid until 1st communication)	<u>None</u> • 1 s • 2 s • 5 s • 10 s • ... • 2 h



Switching output sends	<ul style="list-style-type: none"> <li>• <u>on change</u></li> <li>• on change to 1</li> <li>• on change to 0</li> <li>• on change and periodically</li> <li>• on change to 1 and periodically</li> <li>• on change to 0 and periodically</li> </ul>
Cycle <i>(is only sent if periodically is selected)</i>	<u>5 s</u> • 10 s • 30 s... • 2 h

## Block

The switching output can be blocked using an object.

Use switching output block	<u>No</u> • Yes
----------------------------	-----------------

If the block is activated, define specifications here for the behaviour of the output when blocked.

Analysis of the blocking object	<ul style="list-style-type: none"> <li>• <u>At value 1: block   At value 0: release</u></li> <li>• At value 0: block   At value 1: release</li> </ul>
Blocking object value before first communication	<u>0</u> • 1
Behaviour of the switching output	
On block	<ul style="list-style-type: none"> <li>• <u>Do not send message</u></li> <li>• send 0</li> <li>• send 1</li> </ul>
On release <i>(with 2 seconds release delay)</i>	[Dependent on the "Switching output sends" setting]

The behaviour of the switching output on release is dependent on the value of the parameter "Switching output sends" (see "Switching output")

Switching output sends on change	<ul style="list-style-type: none"> <li>• Do not send message</li> <li>• Send switching output status</li> </ul>
Switching output sends on change to 1	<ul style="list-style-type: none"> <li>• Do not send message</li> <li>• if switching output = 1 → send 1</li> </ul>
Switching output sends on change to 0	<ul style="list-style-type: none"> <li>• Do not send message</li> <li>• if switching output = 0 → send 0</li> </ul>
Switching output sends on change and periodically	Send switching output status
Switching output sends on change to 1 and periodically	if switching output = 1 → send 1
Switching output sends on change to 0 and periodically	if switching output = 0 → send 0

## 6.8. Humidity PI control

If you activate humidity control, you can use the following settings to define control type, setpoint values, and humidification and dehumidification.

Use humidity control	<u>No</u> • Yes
----------------------	-----------------

### General control

**Sensor KNX VOC/TH-UP Touch** can be used to control one- or two-level dehumidification or combined humidification/dehumidification.

Type of control	<ul style="list-style-type: none"> <li>• <u>One-level dehumidification</u></li> <li>• Two-level dehumidification</li> <li>• Humidification and dehumidification</li> </ul>
-----------------	--

Configure a block for the humidity control using the blocking object.

Behaviour of the blocking object with value	<ul style="list-style-type: none"> <li>• <u>1 = block control</u>   <u>0 = release control</u></li> <li>• 0 = block control   1 = release control</li> </ul>
Blocking object value before first communication	<u>0</u> • 1

Specify when the current control variables are to be sent to the bus. Periodic sending is safer, in case a message does not reach a recipient. You may also set up periodic monitoring using an actuator with this setting.

Send control variable	<ul style="list-style-type: none"> <li>• <u>on change</u></li> <li>• on change and periodically</li> </ul>
from change (in % absolute)	1 ... 20, <u>2</u>
Send cycle (is only sent if "periodically" is selected)	5 s • ... • <u>5 min</u> • ... • 2 h

The status object shows the current status of the output variable (0 = OFF, >0 = ON) and can for example be used for visualisation.

Send status object(s)	<ul style="list-style-type: none"> <li>• <u>on change</u></li> <li>• on change to 1</li> <li>• on change to 0</li> <li>• on change and periodically</li> <li>• on change to 1 and periodically</li> <li>• on change to 0 and periodically</li> </ul>
Send cycle (is only sent if "periodically" is selected)	5 s • ... • <u>5 min</u> • ... • 2 h

### Controller setpoint

Set, in which cases **setpoint values** received via object are to be retained. Please note that the setting "After power supply restoration and programming" should not be used

for the initial start-up, as the factory settings are always used until the first communication (setting via objects is ignored).

During initial commissioning, a **setpoint value** must be defined which is valid until the first communication of a new setpoint value. For units which have already been taken into service, the last communicated setpoint value can be used. Basically, an air humidity range is specified in which the setpoint value can be changed (**object value limit**).

Enter, how the setpoint value will be received from the bus. Basically, a new value can be received, or simply a command to increase or decrease.

A set setpoint value will be retained until a new value or a change is transferred. The current value is saved, so that it is retained in the event of a power supply failure and will be available once the power supply is restored.

### **Setpoint value setting using parameter:**

Set the threshold values and hysteresis directly.

Setpoint value setting using	<b>Parameter</b> • Communication objects
Setpoint value in 0.1% RH (valid until 1st communication)	0 ... 100; <u>70</u>

### **Setpoint value setting using communication object:**

Setpoint value setting using	Parameter • <b>Communication objects</b>
The value communicated last shall be maintained	<ul style="list-style-type: none"> <li>• <u>never</u></li> <li>• after power supply restoration</li> <li>• after power supply restoration and programming</li> </ul>
Start setpoint in % valid until first communication <i>(not upon saving the setpoint value after programming)</i>	0 ... 100; <u>50</u> 0...100; <u>40</u>
Object value limit (min.) in %	0...100; <u>60</u>
Object value limit (max.) in %	<u>Absolutwert</u> • Anhebung / Absenkung 1,00% • 2,00% • <u>5,00%</u> • 10,00%

In "Humidification and dehumidification" control mode, a dead zone is specified so that a direct changeover switching between humidification and dehumidification can be avoided.

Dead zone between humidification and dehumidification in % <i>(only if both humidification and dehumidification are used)</i>	0...50; <u>15</u>
--	-------------------

Humidification starts, when the relative air humidity is lower or equal to the setpoint value - dead zone value.

## Dehumidification and/or humidification

Depending on the control mode, settings sections for humidification and dehumidification appear (level 1/2).

For dual-level dehumidification, the setpoint value difference between the two levels must be defined, i.e. the setpoint value which, when exceeded, triggers the switch to the 2nd level.

Target value difference between level 1 and 2 in % (for level 2 only)	0...50; <u>15</u>
--	-------------------

Determine the deviation from the setpoint value at which the maximum variable value is reached, i.e. the point at which maximum output is used.

The reset time shows how quickly the controller responds to deviations from the setpoint value. In case of a short reset time, the control responds with a fast increase of the control variable. In case of a long reset time, the control responds somewhat less urgently and needs longer until the necessary control variable for the setpoint value deviation is reached.

You should set the time appropriate for the humidification/dehumidification system at this point (note manufacturer instructions).

Maximum control variable is reached at target/actual difference of %	1...50; <u>5</u>
Reset time in minutes	1...255; <u>3</u>

Now specify, what should be sent when the control is blocked.

On release, the control variable follows the rule again.

When blocked, the control variable shall	<ul style="list-style-type: none"> <li>• <u>not be sent</u></li> <li>• send a specific value</li> </ul>
Value in % (if a value is sent)	<u>0</u> ...100

## 6.9. Dewpoint measurement

The **Sensor KNX VOC/TH-UP Touch** calculates the dewpoint temperature and can output the value to the bus.

Use dewpoint temperature	<u>No</u> • Yes
Sending pattern	<ul style="list-style-type: none"> <li>• <u>never</u></li> <li>• periodically</li> <li>• on change</li> <li>• on change and periodically</li> </ul>
At and above change of (if sent on change)	<u>0,1</u> °C • 0,2°C • 0,5°C • 1,0°C • 2,0°C • 5,0°C
Send cycle (if sent periodically)	<u>5 s</u> • 10 s • 30 s • 1 min • ... • 2 h

Activate the monitoring of the coolant temperature if required. The menus for setting the monitoring are displayed.

Use monitoring of the coolant temperature	<u>No</u> • Yes
---	-----------------

### 6.9.1. Cooling medium temp. monitoring

A threshold value can be set for the temperature of the coolant, which is based on the current dewpoint temperature (offset/deviation). The switching output of the coolant temperature monitoring system can provide a warning prior to any build-up of condensation in the system, and/or activate appropriate countermeasures.

#### Threshold value

Threshold value = dewpoint temperature + offset

Set, in which cases **offset** received via object is to be retained. Please note that the setting "After power supply restoration and programming" should not be used for the initial start-up, as the factory settings are always used until the first communication (setting via objects is ignored).

The offset communicated last shall be maintained	<ul style="list-style-type: none"> <li>• <u>never</u></li> <li>• after power supply restoration</li> <li>• after power supply restoration and programming</li> </ul>
--	--

During initial commissioning, an **offset** must be defined which is valid until the first communication of a new offset. For units which have already been taken into service, the last communicated offset can be used.

A set offset will be retained until a new value or a change is transferred. The current value is saved, so that it is retained in the event of a power supply failure and will be available once the power supply is restored.

Start offset in °C valid until first communication	0...20; <u>3</u>
Increment for offset change via communication object	0,1°C • 0,2°C • 0,3°C • 0,4°C • 0,5°C • <u>1°C</u> • 2°C • 3°C • 4°C • 5°C
Hysteresis of the threshold value in % (for setting in %)	0 ... 50; <u>20</u>
Threshold value sends	<ul style="list-style-type: none"> <li>• <u>never</u></li> <li>• periodically</li> <li>• on change</li> <li>• on change and periodically</li> </ul>
At and above change of (if sent on change)	<u>0,1°C</u> • 0,2°C • 0,5°C • 1,0°C • 2,0°C • 5,0°C
Send cycle (if sent periodically)	5 s • <u>10 s</u> • 30 s • 1 min • ... • 2 h

## Switching output

The output switching delay can be set using objects or directly as a parameter.

When the following conditions apply, the output is (TV = Threshold value)	<ul style="list-style-type: none"> <li>• TV above = 1   TV - hyst. below = 0</li> <li>• TV above = 0   TV - hyst. below = 1</li> <li>• <u>TV below = 1   TV + hyst. above = 0</u></li> <li>• TV below = 0   TV + hyst. above = 1</li> </ul>
Delays can be set via objects (in seconds)	<u>No</u> • Yes
Switching delay from 0 to 1 for setting via objects: valid until 1st communication	<u>None</u> • 1 s • 2 s • 5 s • 10 s • ... • 2 h
Switching delay from 1 to 0 for setting via objects: valid until 1st communication	<u>None</u> • 1 s • 2 s • 5 s • 10 s • ... • 2 h
Switching output sends	<ul style="list-style-type: none"> <li>• <u>on change</u></li> <li>• on change to 1</li> <li>• on change to 0</li> <li>• on change and periodically</li> <li>• on change to 1 and periodically</li> <li>• on change to 0 and periodically</li> </ul>
Send cycle (is only sent if periodically is selected)	<u>5 s</u> • 10 s • 30 s... • 2 h

## Blocking

The switching output can be blocked using an object. Define specifications here for the behaviour of the output when blocked.

Use switching output block	<u>No</u> • Yes
Analysis of the blocking object	<ul style="list-style-type: none"> <li>• <u>At value 1: block   At value 0: release</u></li> <li>• At value 0: block   At value 1: release</li> </ul>
Blocking object value before first communication	<u>0</u> • 1
Behaviour of the switching output	
On block	<ul style="list-style-type: none"> <li>• <u>Do not send message</u></li> <li>• send 0</li> <li>• send 1</li> </ul>
On release (with 2 seconds release delay)	[Dependent on the "Switching output sends" setting]

The behaviour of the switching output on release is dependent on the value of the parameter "Switching output sends" (see "Switching output")

Switching output sends on change	<ul style="list-style-type: none"> <li>• Do not send message</li> <li>• Send switching output status</li> </ul>
Switching output sends on change to 1	<ul style="list-style-type: none"> <li>• Do not send message</li> <li>• if switching output = 1 → send 1</li> </ul>
Switching output sends on change to 0	<ul style="list-style-type: none"> <li>• Do not send message</li> <li>• if switching output = 0 → send 0</li> </ul>

Switching output sends on change and periodically	Send switching output status
Switching output sends on change to 1 and periodically	if switching output = 1 → send 1
Switching output sends on change to 0 and periodically	if switching output = 0 → send 0

## 6.10. Absolute humidity

The absolute air humidity value is detected by the **KNX VOC/TH-UP Touch** and can be output to the bus.

Use absolute humidity	<u>No</u> • Yes
Sending pattern	<ul style="list-style-type: none"> <li>• <u>never</u></li> <li>• periodically</li> <li>• on change</li> <li>• on change and periodically</li> </ul>
At and above change of (if sent on change)	0,1 g • 0,2 g • 0,5 g • <u>1,0 g</u> • 2,0 g • 5,0 g
Send cycle (if sent periodically)	<u>5 s</u> • 10 s • 30 s... • 2 h

## 6.11. Comfort field

The **Sensor KNX VOC/TH-UP Touch** can send a message to the bus if the limits of the comfort field are exceeded. In this way, it is for example possible to monitor compliance with DIN 1946 (standard values) or even to define your own comfort field.

Use comfort field	<u>No</u> • Yes
Sending pattern	<ul style="list-style-type: none"> <li>• <u>never</u></li> <li>• periodically</li> <li>• on change</li> <li>• on change and periodically</li> </ul>
Send cycle (if sent periodically)	<u>5 s</u> • 10 s • 30 s... • 2 h

Define the comfort field by specifying the minimum and maximum values for temperature and humidity. The specified standard values comply with DIN 1946

Maximum temperature in °C (Standard 26°C)	25 ... 40; <u>26</u>
Minimum temperature in °C (Standard 20°C)	10 ... 21; <u>20</u>
Maximum relative humidity in % (Standard 65%)	52 ... 90; <u>65</u>

Minimum relative humidity in % (Standard 30%)	10 ... 43; <u>30</u>
Maximum absolute humidity in 0.1 g/kg (Standard 115 g/kg)	50 ... 200; <u>115</u>

Temperature hysteresis: 1°C

Relative humidity hysteresis: 2% RH

Absolute humidity hysteresis: 2 g/kg

## 6.12. VOC parameter settings

Use **Offsets** to adjust the readings to be sent.

Offset in ppm	-100...100; <u>0</u>
---------------	----------------------

The unit can calculate a **mixed value** from its own reading and an external value. Set the mixed value calculation if desired. If an external portion is used, all of the following settings (threshold values, etc.) are related to the overall reading.

Use external measured value	<u>No</u> • Yes
Ext. Reading proportion of the total reading	5% • 10% • ... • <u>50%</u> • ... • 100%
All of the following settings are referred to the total value.	
Sending pattern for internal and total measured value	<ul style="list-style-type: none"> <li>• <u>never</u></li> <li>• periodically</li> <li>• on change</li> <li>• on change and periodically</li> </ul>
At and above change of (relative to the last measured value) <i>(if sent on change)</i>	2% • <u>5%</u> • ... • 50%
Send cycle <i>(if sent periodically)</i>	<u>5 s</u> • 10 s • ... • 2 h

The **maximum reading** can be saved and sent to the bus. Using the "Reset VOC maximum value" objects, the value can be reset to the current reading. The value is not retained after a reset.

Use maximum value	<u>No</u> • Yes
-------------------	-----------------

## 6.13. VOC threshold values

Activate the required VOC threshold value. The menus for setting the threshold values are displayed.

Use threshold value 1/2/3/4	Yes • <u>No</u>
-----------------------------	-----------------

300 ppm ... 1000 ppm: fresh air

1000 ppm ... 2000 ppm: used air

1000 ppm = 0.1 %



### 6.13.1. Threshold value 1, 2, 3, 4

#### Threshold value

Set, in which cases **threshold values and delay times** received via object are to be retained. The parameter is only taken into consideration if the setting via object is activated below. Please note that the setting "After power supply restoration and programming" should not be used for the initial start-up, as the factory settings are always used until the first communication (setting via objects is ignored).

Set the threshold value directly in the application program using parameters, or define them via the bus using a communication object.

#### **Threshold value setting using parameters:**

Set the threshold values and hysteresis directly.

Threshold value setting using	<b>Parameter • Communication objects</b>
Threshold value in ppm	0 ... 5000; <u>1200</u>

#### **Threshold value setting using a communication object:**

Define, how the threshold value will be received from the bus. Basically, a new value can be received, or simply a command to increase or decrease.

During initial commissioning, a threshold value must be defined, which will be valid until the first communication of a new threshold value. For units which have already been taken into service, the last communicated threshold value can be used. Basically, a range is specified in which the threshold value can be changed (object value limit).

A set threshold value will be retained until a new value or a change is transferred. The current value is saved, so that it is retained in the event of a power supply failure and will be available once the power supply is restored.

Threshold value setting using	<b>Parameter • Communication objects</b>
The value communicated last shall be maintained	<ul style="list-style-type: none"> <li>• <u>never</u></li> <li>• after power supply restoration</li> <li>• after power supply restoration and programming</li> </ul>
Start threshold value in 0.1°C valid until first communication	0 ... 5000; <u>1200</u>
Limitation of object value (min) in ppm	<u>0</u> ...5000
Limitation of object value (max) in ppm	0...5000; <u>2000</u>
Type of threshold value change	<u>Absolute value</u> • Increase/Decrease
Increment in ppm (upon increase/decrease change)	1 • 2 • 5 • 10 • <u>20</u> • ... • 200

Set the **hysteresis** independent of the type of threshold value specification.

Hysteresis in % of the threshold value	0 ... 50; <u>20</u>
--	---------------------

## Switching output

Set the behaviour of the switching output when a threshold value is exceeded/undercut. The output switching delay can be set using objects or directly as a parameter.

When the following conditions apply, the output is (TV = Threshold value)	<ul style="list-style-type: none"> <li>• <u>TV above = 1</u>   TV - hyst. below = 0</li> <li>• <u>TV above = 0</u>   TV - hyst. below = 1</li> <li>• TV below = 1   TV + hyst. above = 0</li> <li>• TV below = 0   TV + hyst. above = 1</li> </ul>
Delays can be set via objects (in seconds)	<u>No</u> • Yes
Switching delay from 0 to 1 (If delay can be set via objects: valid until first communication)	<u>None</u> • 1 s • 2 s • 5 s • 10 s • ... • 2 h
Switching delay from 1 to 0 (If delay can be set via objects: valid until first communication)	<u>None</u> • 1 s • 2 s • 5 s • 10 s • ... • 2 h
Switching output sends	<ul style="list-style-type: none"> <li>• <u>on change</u></li> <li>• on change to 1</li> <li>• on change to 0</li> <li>• on change and periodically</li> <li>• on change to 1 and periodically</li> <li>• on change to 0 and periodically</li> </ul>
Cycle (is only sent if periodically is selected)	<u>5 s</u> • 10 s • 30 s ... • 2 h

## Block

The switching output can be blocked using an object.

Use switching output block	<u>No</u> • Yes
----------------------------	-----------------

If the block is activated, define specifications here for the behaviour of the output when blocked.

Analysis of the blocking object	<ul style="list-style-type: none"> <li>• <u>At value 1: block</u>   <u>At value 0: release</u></li> <li>• At value 0: block   At value 1: release</li> </ul>
Blocking object value before first communication	<u>0</u> • 1
Behaviour of the switching output	
On block	<ul style="list-style-type: none"> <li>• <u>Do not send message</u></li> <li>• send 0</li> <li>• send 1</li> </ul>
On release (with 2 seconds release delay)	[Dependent on the "Switching output sends" setting]

The behaviour of the switching output on release is dependent on the value of the parameter "Switching output sends" (see "Switching output")

Switching output sends on change	<ul style="list-style-type: none"> <li>• Do not send message</li> <li>• Send switching output status</li> </ul>
----------------------------------	---

Switching output sends on change to 1	<ul style="list-style-type: none"> <li>• Do not send message</li> <li>• if switching output = 1 → send 1</li> </ul>
Switching output sends on change to 0	<ul style="list-style-type: none"> <li>• Do not send message</li> <li>• if switching output = 0 → send 0</li> </ul>
Switching output sends on change and periodically	Send switching output status
Switching output sends on change to 1 and periodically	if switching output = 1 → send 1
Switching output sends on change to 0 and periodically	if switching output = 0 → send 0

## 6.14. VOC PI-control

If you activate air quality control, you can use the following settings to define control type, setpoint values, and ventilation.

Use control	<b>Yes • No</b>
-------------	-----------------

### General control

The **Sensor KNX VOC/TH-UP Touch** can be used to control one or two-stage ventilation.

Type of control	<ul style="list-style-type: none"> <li>• <u>One-stage ventilation</u></li> <li>• <u>Two-stage ventilation</u></li> </ul>
-----------------	--

Configure a block for the ventilation control using the blocking object.

Behaviour of the blocking object with value	<ul style="list-style-type: none"> <li>• <u>1 = block control   0 = release control</u></li> <li>• <u>0 = block control   1 = release control</u></li> </ul>
Blocking object value before first communication	0 • <u>1</u>

Specify when the current control variables are to be sent to the bus. Periodic sending is safer, in case a message does not reach a recipient. You may also set up periodic monitoring using an actuator with this setting.

Send control variable	<ul style="list-style-type: none"> <li>• <u>on change</u></li> <li>• on change and periodically</li> </ul>
at and above change of (in ppm)	1...20; <u>2</u>
Cycle (if sent periodically)	5 s • ... • <u>5 min</u> • ... • 2 h

The status object shows the current status of the output variable (0 = OFF, >0 = ON) and can for example be used for visualisation.

Send status object(s)	<ul style="list-style-type: none"> <li>• <u>on change</u></li> <li>• on change to 1</li> <li>• on change to 0</li> <li>• on change and periodically</li> <li>• on change to 1 and periodically</li> <li>• on change to 0 and periodically</li> </ul>
Cycle (if sent periodically)	<u>5 s</u> • 10 s • ... • 2 h

## Controller setpoint

The setpoint values can be set directly in the application program using parameters, or be defined via the bus using a communication object.

### **Setpoint value setting using parameters:**

Set the setpoint value directly.

Specified setpoint using	<b>Parameter</b> • Communication objects
Target value in ppm	300...5000; <u>800</u>

### **Setpoint value setting via communication object:**

Enter, how the setpoint value will be received from the bus. Basically, a new value can be received, or simply a command to increase or decrease.

During initial commissioning, a setpoint value must be defined which is valid until the first communication of a new setpoint value. For units which have already been taken into service, the last communicated setpoint value can be used. Basically, an air humidity range is given in which the setpoint value can be changed (object value limit).

A set setpoint value will be retained until a new value or a change is transferred. The current value is saved, so that it is retained in the event of a power supply failure and will be available once the power supply is restored.

Threshold value setting using	<b>Parameter</b> • <b>Communication objects</b>
The last communicated value should be retained	<ul style="list-style-type: none"> <li>• <u>never</u></li> <li>• after power supply restoration</li> <li>• after power supply restoration and programming</li> </ul>
Start setpoint value in ppm valid until first communication (not upon saving the setpoint value after programming)	300... 5000; <u>800</u>
Object value limit (min) in ppm	300...5000; <u>400</u>
Object value limit (max) in ppm	300...5000; <u>1500</u>
Type of threshold value change	<u>Absolute value</u> • Increase/decrease
Increment in ppm (upon increase/decrease change)	1 • 2 • 5 • ... • <u>20</u> • ... • 100 • 200

## Ventilation control

Depending on the control mode, one and/or two setting sections for the ventilation stages are displayed.

For two-stage ventilation, the setpoint value difference between the two stages must be defined, i.e. the setpoint value which, when exceeded, triggers the switch to the 2nd level.

Target value difference between 1st and 2nd level in ppm <i>(for level 2 only)</i>	100...2000; <u>400</u>
---	------------------------

Determine the deviation from the setpoint value at which the maximum variable value is reached, i.e. the point at which maximum output is used.

The reset time shows how quickly the controller responds to deviations from the setpoint value. In case of a short reset time, the control responds with a fast increase of the control variable. In case of a long reset time, the control responds somewhat less urgently and needs longer until the necessary control variable for the setpoint value deviation is reached.

You should set the time appropriate to the ventilation system at this point (follow the manufacturer's instructions).

Maximum control variable is reached at setpoint value/actual difference of (in ppm)	<u>100</u> ...2000
Reset time in minutes 1st level	1...255; <u>30</u>
Reset time in minutes 2nd level	1...255; <u>10</u>

Now specify what should be sent when the control is blocked.

On release, the control variable follows the rule again.

When blocked, the control variable shall	<ul style="list-style-type: none"> <li>• <u>not send anything</u></li> <li>• send a value</li> </ul>
Value in % <i>(if a value is sent)</i>	<u>0</u> ...100

## 6.15. Variable comparator

The two integrated control variable comparators can output maximum, minimum and median values.

Use comparator 1/2	<u>No</u> • Yes
--------------------	-----------------

### 6.15.1. Control variable comparator 1/2

Determine what the control variable comparator should output, and activate the input objects to be used. Send behaviour and blocks can also be set.

Output delivered	<ul style="list-style-type: none"> <li>• Maximum value</li> <li>• Minimum value</li> <li>• <u>Average value</u></li> </ul>
Use input 1/2/3/4/5	No • Yes
Output sends	<ul style="list-style-type: none"> <li>• <u>on change of output</u></li> <li>• on change of output and periodically</li> <li>• when receiving an input object</li> <li>• when receiving an input object and periodically</li> </ul>
From change of <i>(is only sent if "on change" is selected)</i>	<u>1%</u> • 2% • 5% • 10% • 20% • 25%
Send cycle <i>(is only sent if "periodically" is selected)</i>	5 s • 10 s • 30 s • ... • <u>5 min</u> • ... • 2 h
Analysis of the blocking object	<ul style="list-style-type: none"> <li>• <u>at value 1: block   at value 0: release</u></li> <li>• at value 0: block   at value 1: release</li> </ul>
Blocking object value before 1st communication	0 • 1
Behaviour of the switching output	
With blocking	<ul style="list-style-type: none"> <li>• <u>do not send message</u></li> <li>• Send value</li> </ul>
Sent value in %	0 ... 100

## 6.16. Logic

The device has 16 logic inputs, four AND- and four OR-logic gates.

Activate the logic inputs and assign object values up to 1st communication. Then, activate the required logic outputs.

Use logic inputs	Yes • <u>No</u>
Object value before 1st communication for	
- Logic input 1	<u>0</u> • 1
- Logic input ...	<u>0</u> • 1
- Logic input 16	<u>0</u> • 1

Activate the required logic outputs.

### AND logic

AND logic 1	<u>not active</u> • active
AND logic ...	<u>not active</u> • active
AND logic 4	<u>not active</u> • active

### OR logic

OR logic 1	<u>not active</u> • active
OR logic ...	<u>not active</u> • active

OR logic 4	<u>not active</u> • active
------------	----------------------------

### 6.16.1. AND logic 1-4 and OR logic outputs 1-4

The same setting options are available for AND and OR logic.

Each logic output may transmit one 1 bit or two 8 bit objects. Determine what the output should send if logic = 1 and = 0.

1. / 2. / 3. / 4. Input	<ul style="list-style-type: none"> <li>• <u>do not use</u></li> <li>- Logic inputs 1...16</li> <li>- Logic inputs 1...16 inverted</li> <li>• all switching events that the device provides (see <i>Connection inputs of the AND/OR logic</i>)</li> </ul>
Output type	<ul style="list-style-type: none"> <li>• <u>a 1-Bit-object</u></li> <li>• two 8-bit objects</li> </ul>

If the **output type is a 1-bit object**, set the output values for the various conditions.

Output value if logic = 1	<u>1</u> • 0
Output value if logic = 0	1 • <u>0</u>

If the **output type is two 8-bit objects**, set the type of object and the output values for the various conditions.

Object type	<ul style="list-style-type: none"> <li>• <u>Value (0...255)</u></li> <li>• Percent (0...100%)</li> <li>• Angle (0...360°)</li> <li>• Scene call-up (0...127)</li> </ul>
Output value object A if logic = 1	0 ... 255 / 100% / 360° / 127; <u>1</u>
Output value object B if logic = 1	0 ... 255 / 100% / 360° / 127; <u>1</u>
Output value object A if logic = 0	0 ... 255 / 100% / 360° / 127; <u>0</u>
Output value object B if logic = 0	0 ... 255 / 100% / 360° / 127; <u>0</u>

Set the output send pattern.

Send pattern	<ul style="list-style-type: none"> <li>• <u>on change of logic</u></li> <li>• on change of logic to 1</li> <li>• on change of logic to 0</li> <li>• on change of logic and periodically</li> <li>• on change of logic to 1 and periodically</li> <li>• on change of logic to 0 and periodically</li> <li>• on change of logic+object receipt</li> <li>• on change of logic+object receipt and periodically</li> </ul>
Send cycle (if sent periodically)	5 s • <u>10 s</u> • ... • 2 h

## Block

If necessary, activate the block for the logic output and set what a 1 or 0 at the block input means and what happens in the event of a block.

Analysis of the blocking object	<ul style="list-style-type: none"> <li>• <u>At value 1: block   At value 0: release</u></li> <li>• <u>At value 0: block   At value 1: release</u></li> </ul>
Blocking object value before first call	<u>0</u> • 1
Behaviour of switching output	
On block	<ul style="list-style-type: none"> <li>• <u>Do not send message</u></li> <li>• <u>Transmit block value [see above, Output value if blocking active]</u></li> </ul>
On release (with 2 seconds release delay)	[send value for current logic status]

### 6.16.2.Connection inputs of the AND logic

do not use

Logic input 1

Logic input 1 inverted

Logic input 2

Logic input 2 inverted

Logic input 3

Logic input 3 inverted

Logic input 4

Logic input 4 inverted

Logic input 5

Logic input 5 inverted

Logic input 6

Logic input 6 inverted

Logic input 7

Logic input 7 inverted

Logic input 8

Logic input 8 inverted

Logic input 9



Logic input 9 inverted  
Logic input 10  
Logic input 10 inverted  
Logic input 11  
Logic input 11 inverted  
Logic input 12  
Logic input 12 inverted  
Logic input 13  
Logic input 13 inverted  
Logic input 14  
Logic input 14 inverted  
Logic input 15  
Logic input 15 inverted  
Logic input 16  
Logic input 16 inverted  
Temperature/Humidity sensor malfunction = ON  
Temperature/Humidity sensor malfunction = OFF  
VOC sensor malfunction ON  
VOC sensor malfunction OFF  
Switching output temperature 1  
Switching output temperature 1 inverted  
Switching output temperature 2  
Switching output temperature 2 inverted  
Switching output temperature 3  
Switching output temperature 3 inverted  
Comfort temperature controller active  
Comfort temperature controller inactive  
Eco temperature controller active  
Eco temperature controller inactive  
Standby temperature controller active  
Standby temperature controller inactive  
Temperatur controller frost/heat active  
Temperatur controller frost/heat inactive  
Temp. control status heating 1  
Temp. control status heating 1 inverted  
Temp. control status heating 2  
Temp. control status heating 2 inverted  
Temp. control status cooling 1  
Temp. control status cooling 1 inverted  
Temp. control status cooling 2  
Temp. control status cooling 2 inverted  
Switching output humidity 1  
Switching output humidity 1 inverted  
Switching output humidity 2  
Switching output humidity 2 inverted  
Humidity control status dehumidification 1  
Humidity control status dehumidification 1 inv.

Humidity control status dehumidification 2  
 Humidity control status dehumidification 2 inv.  
 Humidity control status humidification  
 Humidity control status humidification inverted  
 Switching output coolant temperature  
 Switching output coolant temperature inverted  
 Switching output cooling medium temperature  
 Switching output cooling medium temperature inv.  
 Switching output room climate status  
 Switching output room climate status inverted  
 Switching output VOC 1  
 Switching output VOC 1 inverted  
 Switching output VOC 2  
 Switching output VOC 2 inverted  
 Switching output VOC 3  
 Switching output VOC 3 inverted  
 Switching output VOC 4  
 Switching output VOC 4 inverted  
 VOC controller status ventilation 1  
 VOC controller status ventilation 1 inverted  
 VOC controller status ventilation 2  
 VOC controller status ventilation 2 inverted

### 6.16.3. Connection inputs of the OR logic

---

The OR logic connection inputs correspond to those of the AND logic. In addition the following inputs are available for the OR logic:

AND logic 1  
 AND logic output 1 inverted  
 AND logic output 2  
 AND logic output 2 inverted  
 AND logic output 3  
 AND logic output 3 inverted  
 AND logic output 4  
 AND logic output 4 inverted

## 6.17. Display

---

Adjust the display settings here.

Use display lighting	<u>No</u> • <b>Yes</b>
Brightness in % up to 1. Communication	0 ... 255; <u>100</u>
Lighting	<u>always on</u> • only when operating

Switch off delay after operation until 1st communication (in seconds)	1 ... 600; <u>10</u>
Saving brightness and switch off delay	<ul style="list-style-type: none"> <li>• <u>never</u></li> <li>• after power restoration</li> <li>• after power restoration and programming</li> </ul>

Set contrast and number of lines, as well as the type of temperature target value display.

Use object "display contrast"	<u>No</u> • Yes
Display mode	<ul style="list-style-type: none"> <li>• two lines (with optional thermostat display)</li> <li>• <u>three lines</u> (with optional thermostat display)</li> <li>• Permanent thermostat</li> </ul>
Temperature controller display when using pushbutton	<u>No</u> • <b>Yes</b>
<i>only possible if the pushbuttons are also set to "For temperature control")</i>	
Type of temperature target value display ( <i>only for active thermostat display</i> )	<ul style="list-style-type: none"> <li>• <u>Current target value</u></li> <li>• Basic setpoint</li> <li>• Basic setpoint as bar chart</li> <li>• Basic setpoint as bar chart with count</li> <li>• Basic setpoint as bar chart with range</li> <li>• Basic setpoint as bar chart with range and count</li> </ul>
Display duration in seconds for Temperature controller display	2...240; <u>5</u>

Choose if you would like to use the return release.

Use object "Return approval"	<u>No</u> • <b>Yes</b>
Object evaluation	<ul style="list-style-type: none"> <li>• <u>1= Allow return   0=Return not allowed</u></li> <li>• 1= Allow return   0=Return not allowed</li> </ul>
Object value prior to initial communication	0 • <u>1</u>

Choose if input objects should be used.

Use input objects	<u>No</u> • Yes
-------------------	-----------------

Set what should appear on the display.

Content line 1 (small font size)	<ul style="list-style-type: none"> <li>• display nothing</li> <li>• <u>internal temperature</u></li> <li>• other selection options</li> </ul>
Content line 2 (large font size)	<ul style="list-style-type: none"> <li>• display nothing</li> <li>• <u>VOC internal reading</u></li> <li>• other selection options</li> </ul>

Content line 3 (small font size)	<ul style="list-style-type: none"> <li>• display nothing</li> <li>• <u>relative humidity internal</u></li> <li>• other selection options</li> </ul>
----------------------------------	---

The following table contains a list of other selection options.

List with other selection options:

External temperature Total temperature Current thermostat target value Dew point temperature relative humidity external relative humidity total absolute humidity g/kg absolute humidity g/m <sup>3</sup> VOC external reading VOC total reading Date (Not for line 2!) Time	
8-bit object value 1 8-bit object value 2 8-bit object value 3	<ul style="list-style-type: none"> <li>• <u>without [0 ... 255]</u></li> <li>• percentage [0% ... 100%]</li> <li>• degree [0° ... 360°]</li> </ul>

16-bit object value 1 16-bit object value 2 (Not for line 2!)	<ul style="list-style-type: none"> <li>• <u>without</u></li> <li>• °C (degree Celsius)</li> <li>• lux</li> <li>• m/s (metres per second)</li> <li>• Pa (Pascal)</li> <li>• bar</li> <li>• mbar (millibar)</li> <li>• % R.H. (% relative humidity)</li> <li>• ppm (parts per million)</li> <li>• s (second)</li> <li>• ms (millisecond)</li> <li>• v (volt)</li> <li>• mV (millivolt)</li> <li>• A (ampere)</li> <li>• mA (milliampere)</li> <li>• W (watt)</li> <li>• mW (milliwatt)</li> <li>• W/m<sup>2</sup> (watt per square meter)</li> <li>• W/h (watt per hour)</li> <li>• ltr (litre)</li> <li>• ltr/h (litre per hour)</li> <li>• m (meter)</li> <li>• mm (millimetre)</li> </ul>
Text message 1 Text message 2 (Not for line 2!)	Display duration of the message: <ul style="list-style-type: none"> <li>• <u>until new notification available</u></li> <li>• max. 1 minute</li> <li>• ...</li> <li>• max. 60 minutes</li> </ul>

## 6.18. Pushbutton

Adjust the pushbutton settings here.

### 6.18.1. Pushbutton for temperature control

Use pushbutton	<ul style="list-style-type: none"> <li>• as button interface</li> <li>• <u>for temperature control</u></li> </ul>
Pushbutton functions	<p>Left button (short) --&gt; target temperature down Right button (short) --&gt; target temperature up</p> <p>Left button (longer than 2 sec) --&gt; mode switch Right button (longer than 2 sec) --&gt; mode switch</p> <p>If both buttons are pressed in eco mode for more than 2 seconds, comfort mode is activated for the set duration.</p>
The following modes can be selected by pushbutton:	
Comfort	No • <u>Yes</u>
Standby	No • <u>Yes</u>
Eco	No • <u>Yes</u>
Building protection	<u>No</u> • Yes

### 6.18.2. Pushbutton interface

Choose if you would like to use the button as a button interface, and set the function.

Use pushbutton interface	<u>No</u> • Yes
Function	<ul style="list-style-type: none"> <li>• <u>Switch</u></li> <li>• Changeover switch</li> <li>• Shutter</li> <li>• Roller blind</li> <li>• Awning</li> <li>• Window</li> <li>• Dimmer</li> <li>• 8-bit encoder</li> <li>• 16-bit encoder</li> <li>• Scenario recall</li> </ul>

Define which values are sent when the button is pressed/released, and when these are sent.

Command when pressing the pushbutton	<ul style="list-style-type: none"> <li>• send 0</li> <li>• send 1</li> <li>• <u>do not send message</u></li> </ul>
Command when releasing the pushbutton	<ul style="list-style-type: none"> <li>• send 0</li> <li>• send 1</li> <li>• <u>do not send message</u></li> </ul>

Send value	<ul style="list-style-type: none"> <li>• <u>on change</u></li> <li>• on change to 1</li> <li>• on change to 0</li> <li>• on change and periodically</li> <li>• on change to 1 and periodically</li> <li>• on change to 0 and periodically</li> </ul>
Cycle (if sent periodically)	5 s • ... • <u>1 min</u> • ... • 2 h

### **Changeover switching**

Command when pressing the pushbutton	<ul style="list-style-type: none"> <li>• Changeover switching</li> <li>• <u>do not send message</u></li> </ul>
Command when releasing the pushbutton	<ul style="list-style-type: none"> <li>• Changeover switching</li> <li>• <u>do not send message</u></li> </ul>

### **Blind**

Pushbutton function	<ul style="list-style-type: none"> <li>• <u>Up</u></li> <li>• Down</li> </ul>
Control mode	<ul style="list-style-type: none"> <li>• <u>Standard</u></li> <li>• Standard inverted</li> <li>• Comfort mode</li> <li>• Dead man's switch</li> </ul>

#### Standard:

Behaviour for button actuation (up): short = Stop/Step   long = Up	
Behaviour for button actuation (down): short = Stop/Step   long = Down	
Time between short and long in 0.1 seconds	0 ... 50; <u>10</u>

#### Standard inverted:

Behaviour for button actuation (up): long = Stop/Step   short = Up	
Behaviour for button actuation (down): short = Stop/Step   long = Down	
Time between short and long in 0.1 seconds	0 ... 50; <u>10</u>
Repeat the step command for a long button press	every 0.1 s • every 2 sec; <u>every 0.5 sec</u>

#### Comfort mode:

Button is pushed and	
released before time 1 expired	stop/step
held longer than time 1	Up or Down
released between time 1 and 1-2	Stop
released after time 1 +2	no more stop
Time 1 (in 0,1 s)	0 ... 50; <u>4</u>
Time 2 (in 0,1 s)	0 ... 50; <u>20</u>

Dead man's switch:

Push button	down command
Release button	up command

### Shutter

Pushbutton function	<ul style="list-style-type: none"> <li>• <u>Up</u></li> <li>• Down</li> <li>• Up/Down</li> </ul>
Control mode	<ul style="list-style-type: none"> <li>• <u>Standard</u></li> <li>• Standard inverted</li> <li>• Comfort mode</li> <li>• Dead man's switch</li> </ul>

Standard:

Behaviour for button actuation (up): short = Stop   long = Up	
Behaviour for button actuation (down): short = Stop   long = Down	
Behaviour in case of button actuation (up/down): short = Stop   long = Up/Down	
Time between short and long in 0.1 seconds	0 ... 50; <u>10</u>

Standard inverted

Behaviour for button actuation (up): long = Stop   short = Up	
Behaviour for button actuation (down): short = Stop   long = Down	
Behaviour in case of button actuation (up/down): short = Stop   long = Up/Down	
Time between short and long in 0.1 seconds	0 ... 50; <u>10</u>
Repeat the step command for a long button press (only Up)	no • every 0,1 s • ... • <u>every 0,5 s</u> • ... • every 2 s

Comfort mode:

Button is pushed and released before time 1 expired	Stopp
held longer than time 1	Up   Down   Up/Down
released between time 1 and 1-2	Stop
released after time 1 +2	no more stop
Time 1 (in 0,1 s)	0 ... 50; <u>4</u>
Time 2 (in 0,1 s)	0 ... 50; <u>20</u>

Dead man's switch:

Push button	Up-   Down-   Up/Down command
Release button	Stop command



**Awning**

Pushbutton function	<ul style="list-style-type: none"> <li>• <u>Retract</u></li> <li>• Extend</li> <li>• Retract/Extend</li> </ul>
Control mode	<ul style="list-style-type: none"> <li>• <u>Standard</u></li> <li>• Standard inverted</li> <li>• Comfort mode</li> <li>• Dead man's switch</li> </ul>

## Standard:

Behaviour in case of button actuation (retract): short = Stop   long = Retract	
Behaviour in case of button actuation (extend): short = Stop   long = Extend	
Behaviour in case of button actuation (retract/extend): short = Stop   long = Retract/Extend	
Time between short and long in 0.1 seconds	0 ... 50; <u>10</u>

## Standard inverted:

Behaviour in case of button actuation (retract): long = Stop   short = Retract	
Behaviour in case of button actuation (extend): long = Stop   short = Extend	
Behaviour in case of button actuation (retract/extend): long = Stop   short = Retract/Extend	
Time between short and long in 0.1 seconds	0 ... 50; <u>10</u>
Repeat the step command for a long button press (only Up)	no • every 0,1 s • ... • <u>every 0,5 s</u> • ... • every 2 s

## Comfort mode:

Button is pushed and released before time 1 expired	Stop
held longer than time 1	On   Off   On/Off
released between time 1 and 1-2	Stop
released after time 1 +2	no more stop
Time 1 (in 0,1 s)	0 ... 50; <u>4</u>
Time 2 (in 0,1 s)	0 ... 50; <u>20</u>

## Dead man's switch:

Push button	On-   Off-   On/Off command
Release button	Stop command

**Window**

Pushbutton function	<ul style="list-style-type: none"> <li>• <u>C</u>lose</li> <li>• Open</li> <li>• Open/<u>C</u>lose</li> </ul>
Control mode	<ul style="list-style-type: none"> <li>• <u>S</u>tandard</li> <li>• Standard inverted</li> <li>• Comfort mode</li> <li>• Dead man's switch</li> </ul>

## Standard:

Behaviour in case of button actuation (close): short = Stop   long = Close	
Behaviour for button actuation (up): short = Stop   long = Up	
Behaviour in case of button actuation (open/close): short = Stop   long = Open/Close	
Time between short and long in 0.1 seconds	0 ... 50; <u>10</u>

## Standard inverted:

Behaviour in case of button actuation (close): long = Stop   short = Close	
Behaviour for button actuation (up): long = Stop   short = Up	
Behaviour in case of button actuation (open/close) long = Stop   short = Open/Close	
Time between short and long in 0.1 seconds	0 ... 50; <u>10</u>
Repeat the step command for a long button press (only Up)	no • every 0,1 s • ... • <u>every 0,5 s</u> • ... • every 2 s

## Comfort mode:

Button is pushed and released before time 1 expired	stop/step
held longer than time 1	Up or Down
released between time 1 and 1-2	Stop
released after time 1 +2	no more stop
Time 1 (in 0,1 s)	0 ... 50; <u>4</u>
Time 2 (in 0,1 s)	0 ... 50; <u>20</u>

## Dead man's switch:

Push button	Close-   Up-   Open/Close command
Release button	Stop command

**Dimmer**

Pushbutton function	• <u>Brighter</u> • darker • Brighter/darker
Time between switching and dimming in 0.1 seconds	0 ... 50; 5
Repetition of the dimming command	<u>No</u> • <b>Yes</b>
Repetition of the dimming command upon extended button actuation	every 0,1 s • ... • <u>every 0,5 s</u> • ... • every 2 s
Dimming by	100% • ... • <u>6%</u> • ... • 1,5%

**8 bit encoder**

Value range	<ul style="list-style-type: none"> <li>• <u>0</u> ... 255</li> <li>• 0% ... 100%</li> <li>• 0° ... 360°</li> </ul>
Value	<ul style="list-style-type: none"> <li>• <u>0</u>... 255</li> <li>• <u>0</u> ... 100</li> <li>• <u>0°</u>... 360°</li> </ul>

**16 bit encoder:**

Value in 0.1	-6707600 ... 6707600; <u>0</u>
--------------	--------------------------------

**Scenario control:**

Scenario no.	<u>0</u> ... 127
--------------	------------------



**Elsner Elektronik GmbH** Control and Automation Engineering

Sohlengrund 16  
75395 Ostelsheim  
Germany

Phone +49 (0) 70 33 / 30 945-0 [info@elsner-elektronik.de](mailto:info@elsner-elektronik.de)  
Fax +49 (0) 70 33 / 30 945-20 [www.elsner-elektronik.de](http://www.elsner-elektronik.de)

---

*Technical support: +49 (0) 70 33 / 30 945-250*